

Non cylindrical symmetric Shocks in liquid jets

TT2A-scheme

Nufact Hg-jet target experiment in the N-ToF tunnel
classical + Hg tank for ~dc-pump

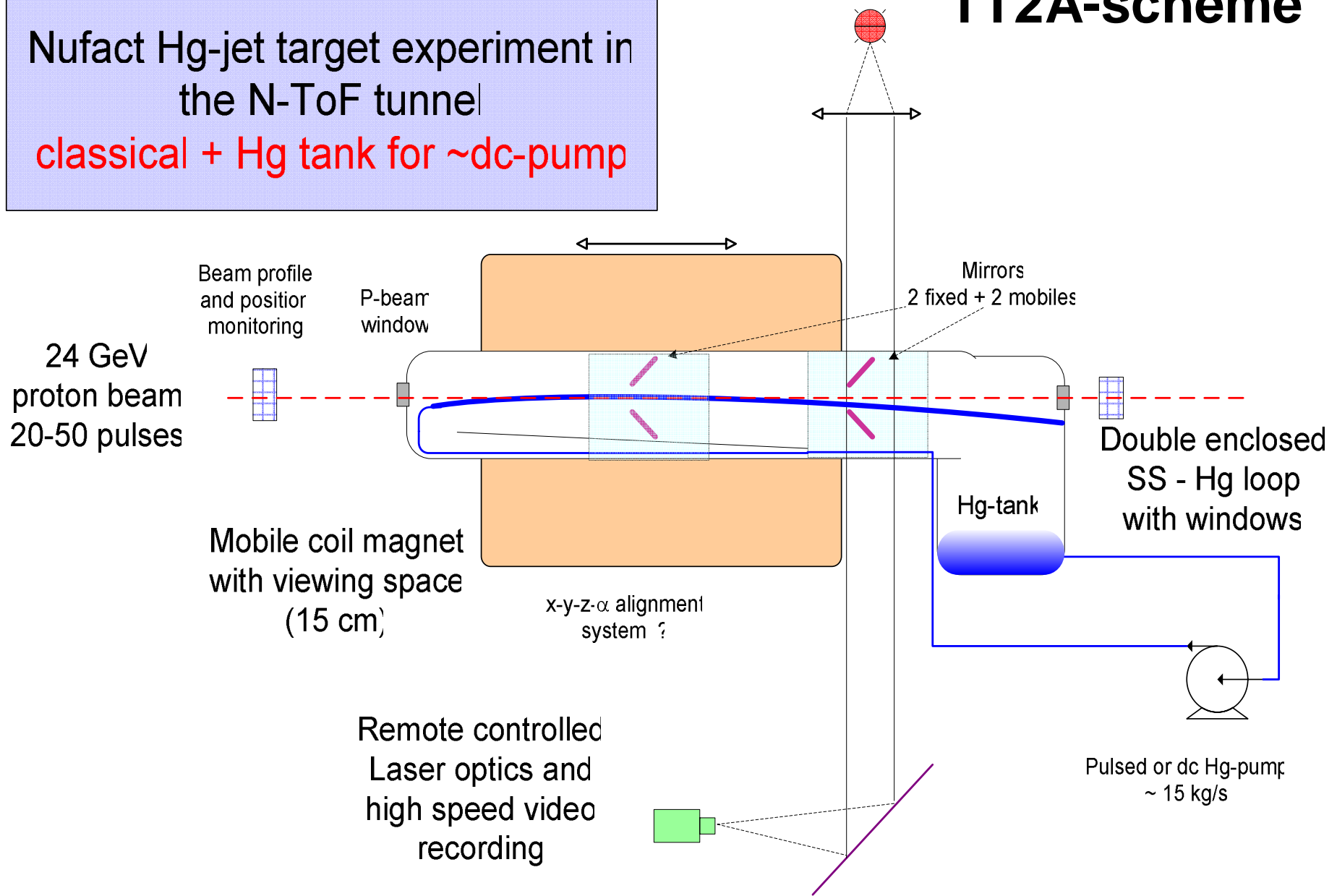

TT2a experiment

Hg jet velocity 12 m/s
diameter 10 mm

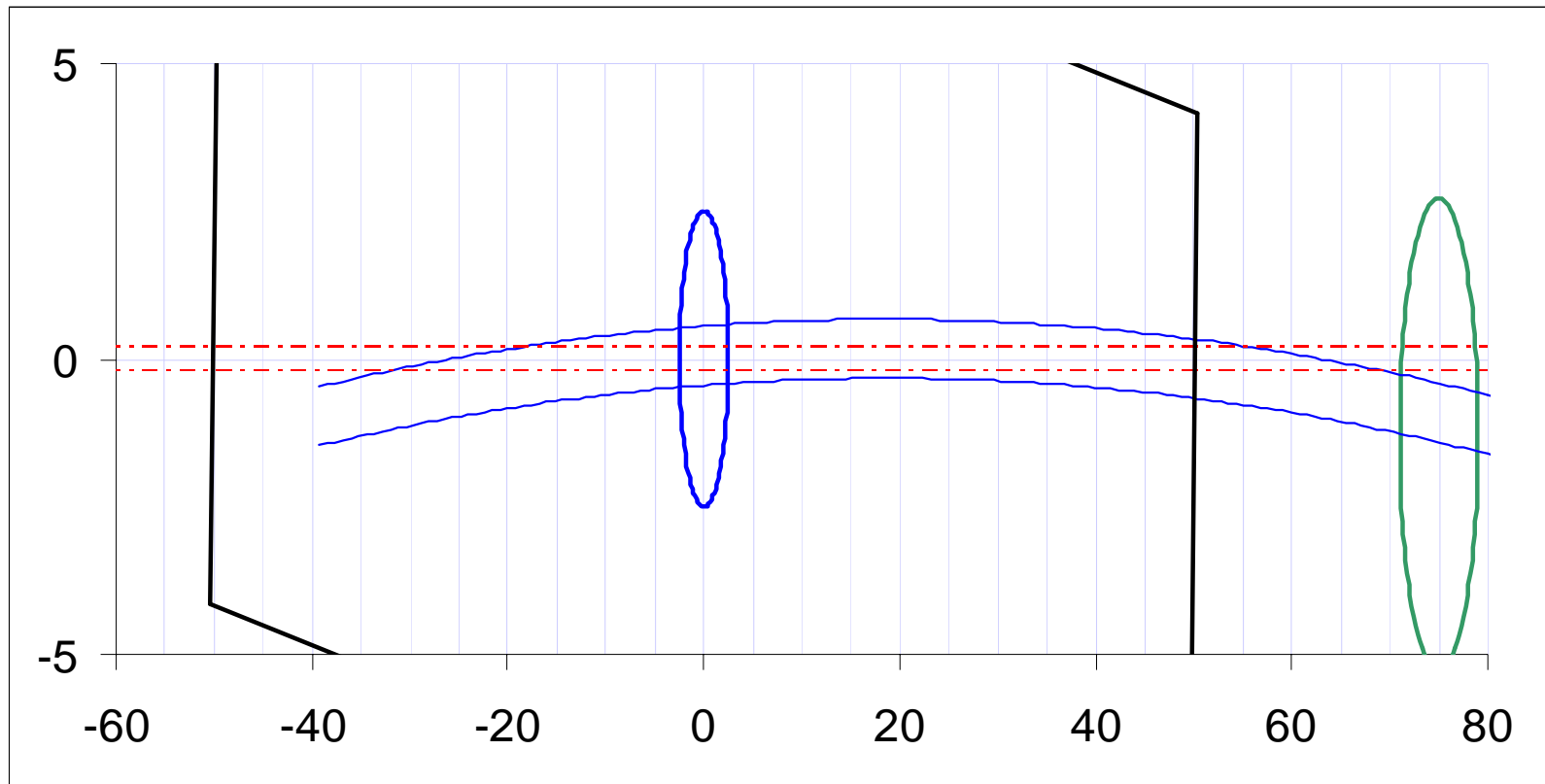

Laser setup

Dipl. E. Robert EPFL

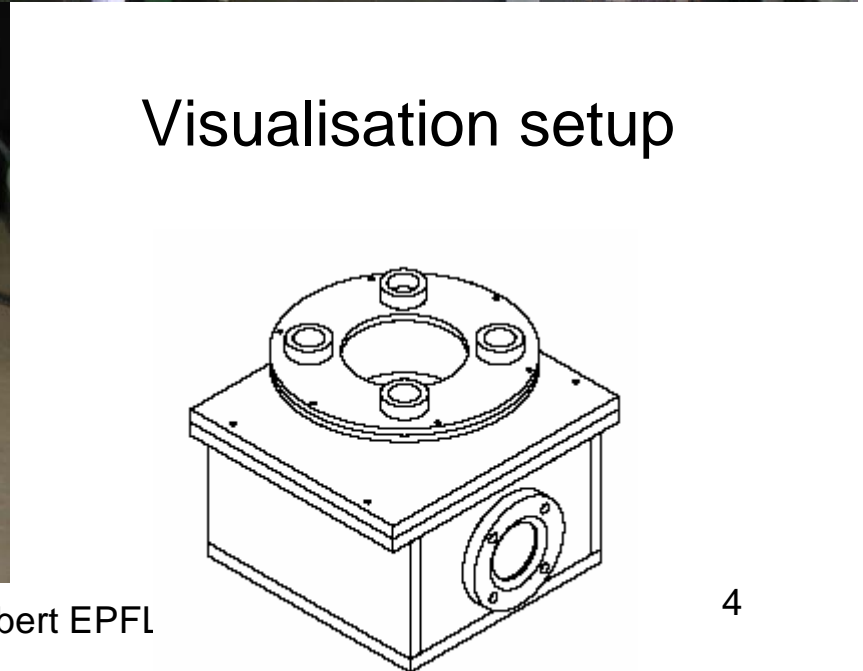
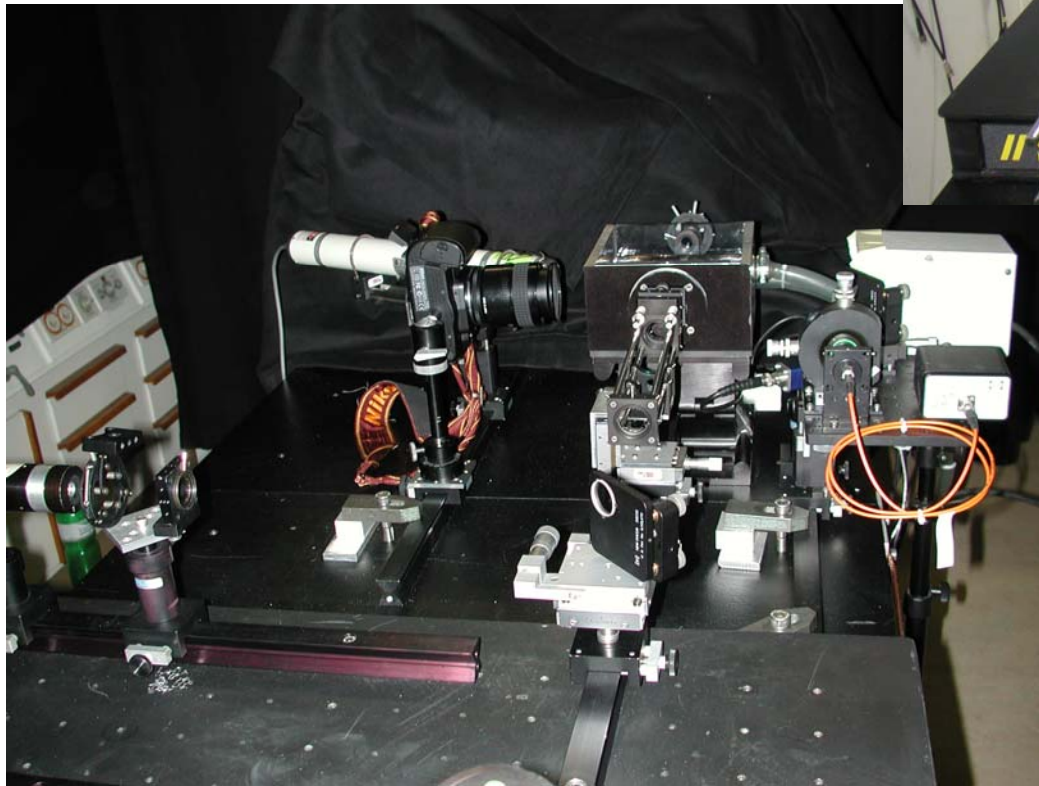
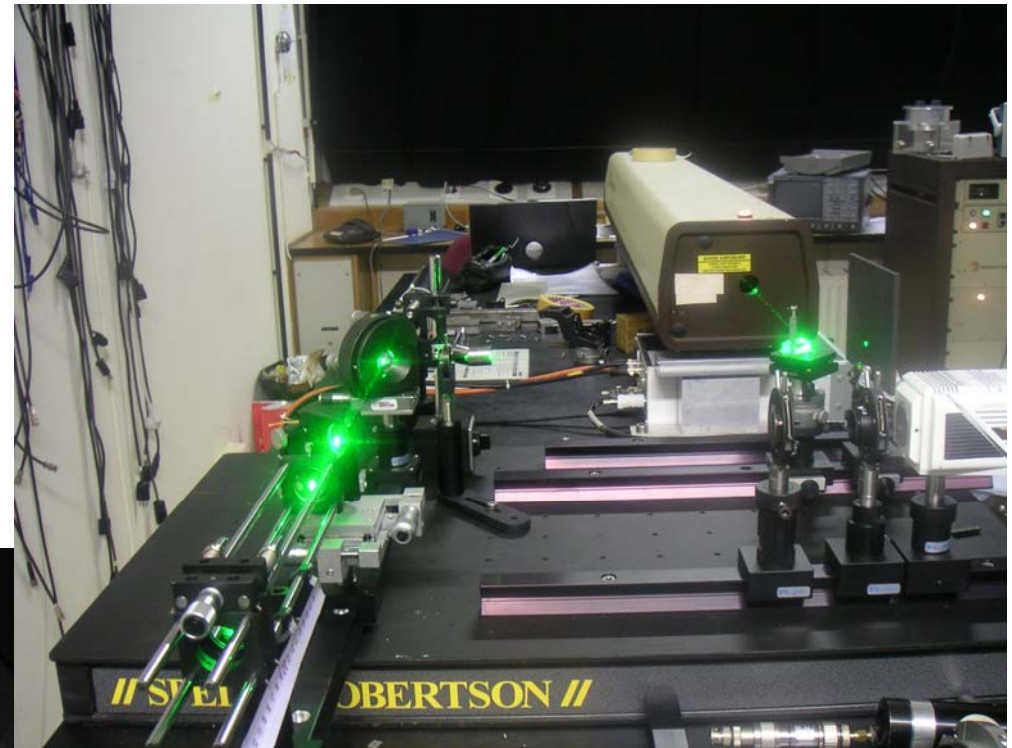

15th March 2005

J. Lettry CERN, E. Robert EPFL

Laser induced cavitation bubbles in a laminar water jet

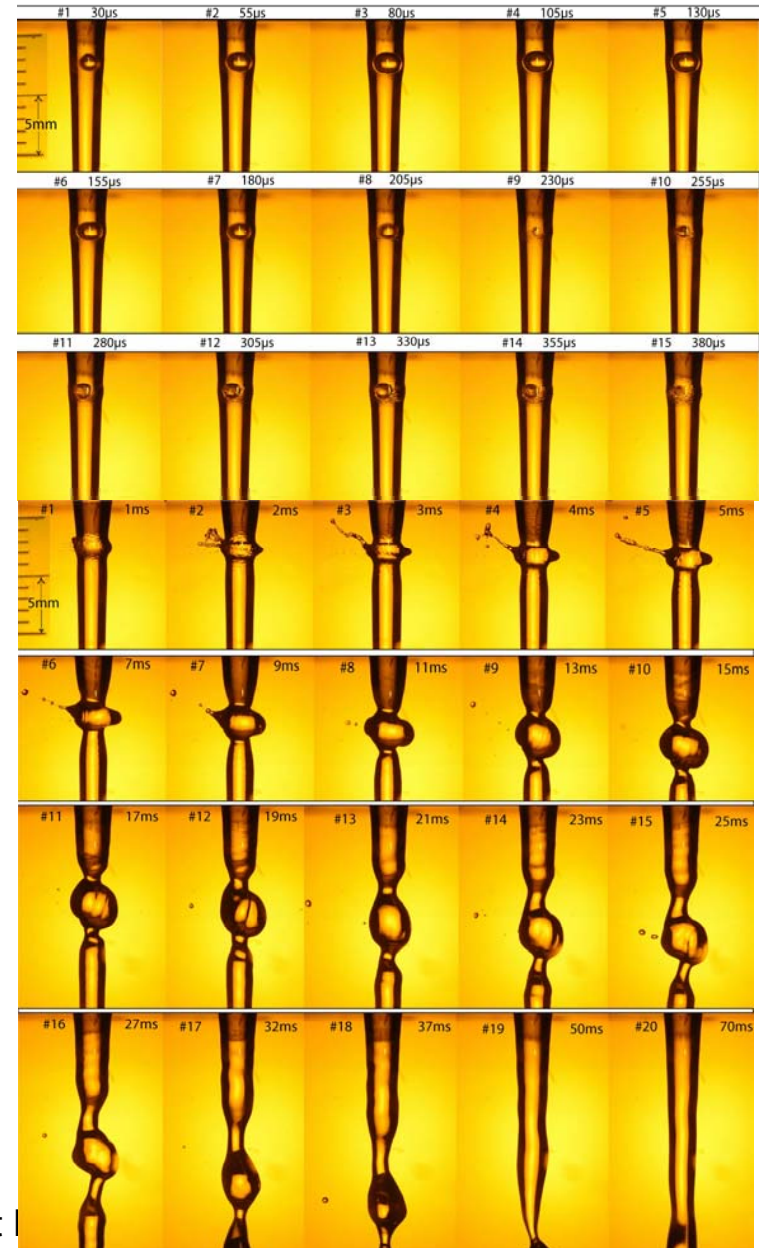
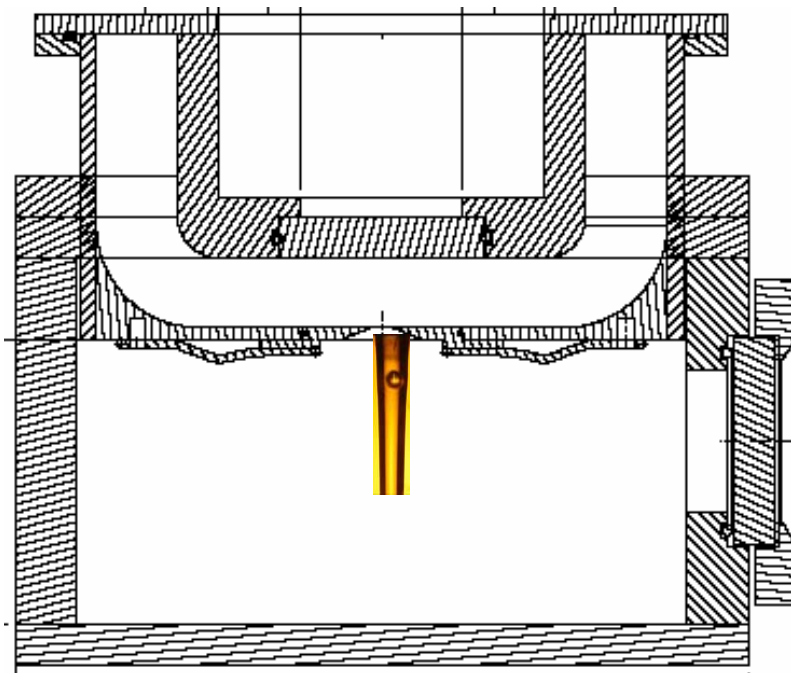

15th March 2005

J. Lettry CERN, E. Robert

Symmetric and Asymmetric bubble collapse

(Film to slide under preparation 15/3/05)

Water jet ripples generated by a 8 mJ Laser cavitation bubble



15th March 2005

J. Lettry CERN, E. Robert EPFL

Mercury target: evolution after the third proton pulse (20 - 35 microseconds)

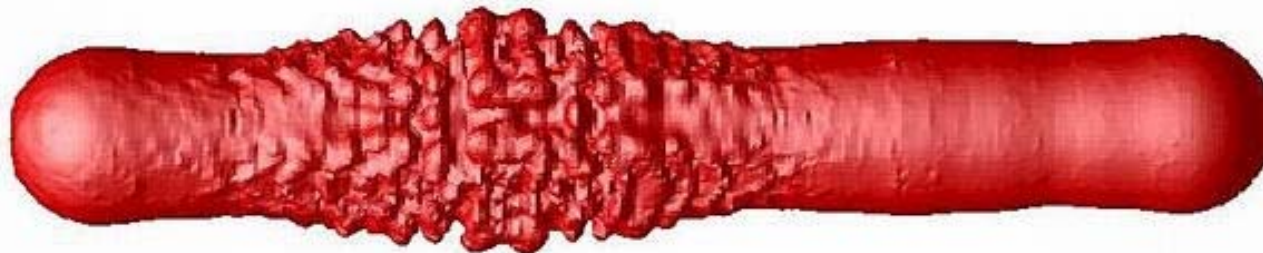
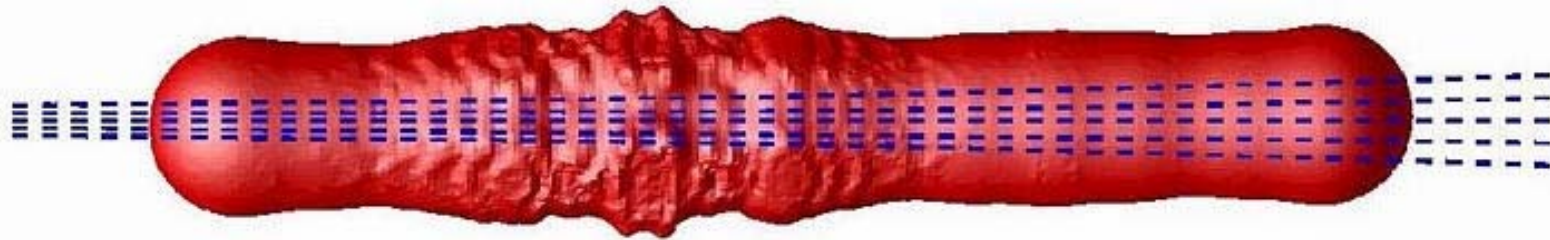

Brookhaven Science Associates
U.S. Department of Energy

R. Samulyak



Conclusion TT2a

- Hadronic cascade simulation for a realistic irradiation geometry is mandatory to our understanding of the results
- We expect non symmetric irradiation therefore micro jets ...
- Timing of the images is a critical parameter that deserves a preliminary test.

Target

- Evolution of material parameters under fatigue and irradiation via laser vibrometry monitoring of vibration eigenfrequencies (R. Wilfinger, EURISOL-DS task)
- Test of the stability of a High temperature Ta-cylinder under pulsed irradiation
- Test of a Ta-beed target
- Tests of the effects of very short (250 to 30 ns) proton bunches for molten and solid targets

Horn

- Test of the Horn at nominal parameters (current and pulse duration). Dedicated power supply required for single pulses and 50Hz operation (the Nominal 50Hz power supply is worth 800 k€).
- Measurement at low repetition rate of π yields and momentum distributions for various targets assemblies (solid, liquid, beads) inserted in the “available” horn.

Conclusion targetry R&D

- The most missing infrastructure required to continue this R& D effort is a dedicated experimental area capable of delivering 2 to 24 GeV proton pulses and designed to face the various safety aspects (Chemistry of heavy metals, high radiation levels, High voltage, high current ...).