

# A Feasibility Study of a Neutrino Source Based on a Muon Storage Ring

edited by:

Norbert Holtkamp  
David Finley

Contributions from: 20 FTE during 6 months at Fermilab plus about  
50 FTE from other labs. 12 named authors from CERN, 3 from RAL

## **Charge for the purpose of this study**

1. A design concept for a muon storage ring and associated support facilities that could, with reasonable assurance, meet performance goals required to support a compelling neutrino based research program.
2. Identification of the likely cost drivers within such a facility.
3. Identification of an R&D program that would be required to address key areas of technological uncertainty and cost/performance optimization within this design, and that would, upon successful completion, allow one to move with confidence into the conceptual design stage of such a facility.
4. Identification of any specific environmental, safety, and health issues that will require our attention.



# Organization for the Neutrino Source Study

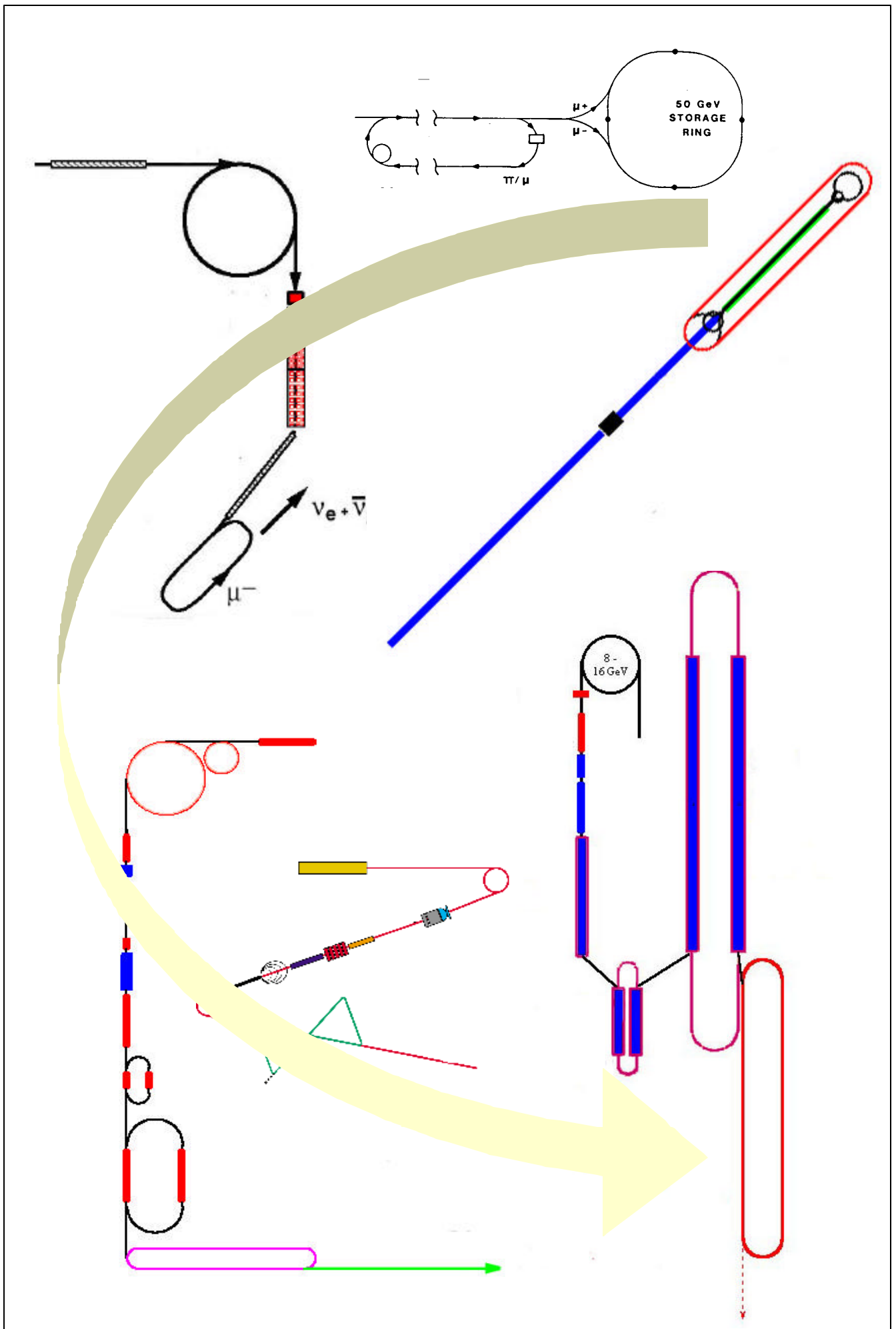
Sub-Component	Status	Risk	Save money?	Responsible person for the chapter in the report
	Can we build it?		Make it easier?	
Proton Driver	ok yes	moderate	yes less intensity longer bunches	W. Chou
Target	not ok no	high	power on target	T. Gabriel, ORNL S. Childress N. Mokhov
Decay channel + $\phi$ rot	not ok may be	high	no back off in present design	V. Balbekov
mini cooling (factor of 3)  (3 m LH2)	ok yes	low	no for this design  less intensity	D. Kaplan
2 <sup>nd</sup> $\phi$ -rotation  (induct) linac	not ok may be	very high	only in exchange with low frequ. RF	N. Holtkamp LBNL
capture	not ok mainly rf problem	high	no (a little) lower Frequ. rf	D. Neuffer
cooling (factor of 50)	not ok mainly rf problem	high	no (a little) lower Frequ. rf	S. Geer D. Kaplan, P. Lebrun,
1 <sup>st</sup> stage linac together with next row (RLAS)	½ ok yes	moderate	no	CEBAF Cornell C. Bohn
RLA's	½ ok yes	moderate	no	CEBAF Cornell C. Bohn
Storage Ring	ok yes	moderate	no compromise flux	S. Ohnuma, Texas D. Finley C. Johnstone
Diagnostic	not ok	moderate	no	?

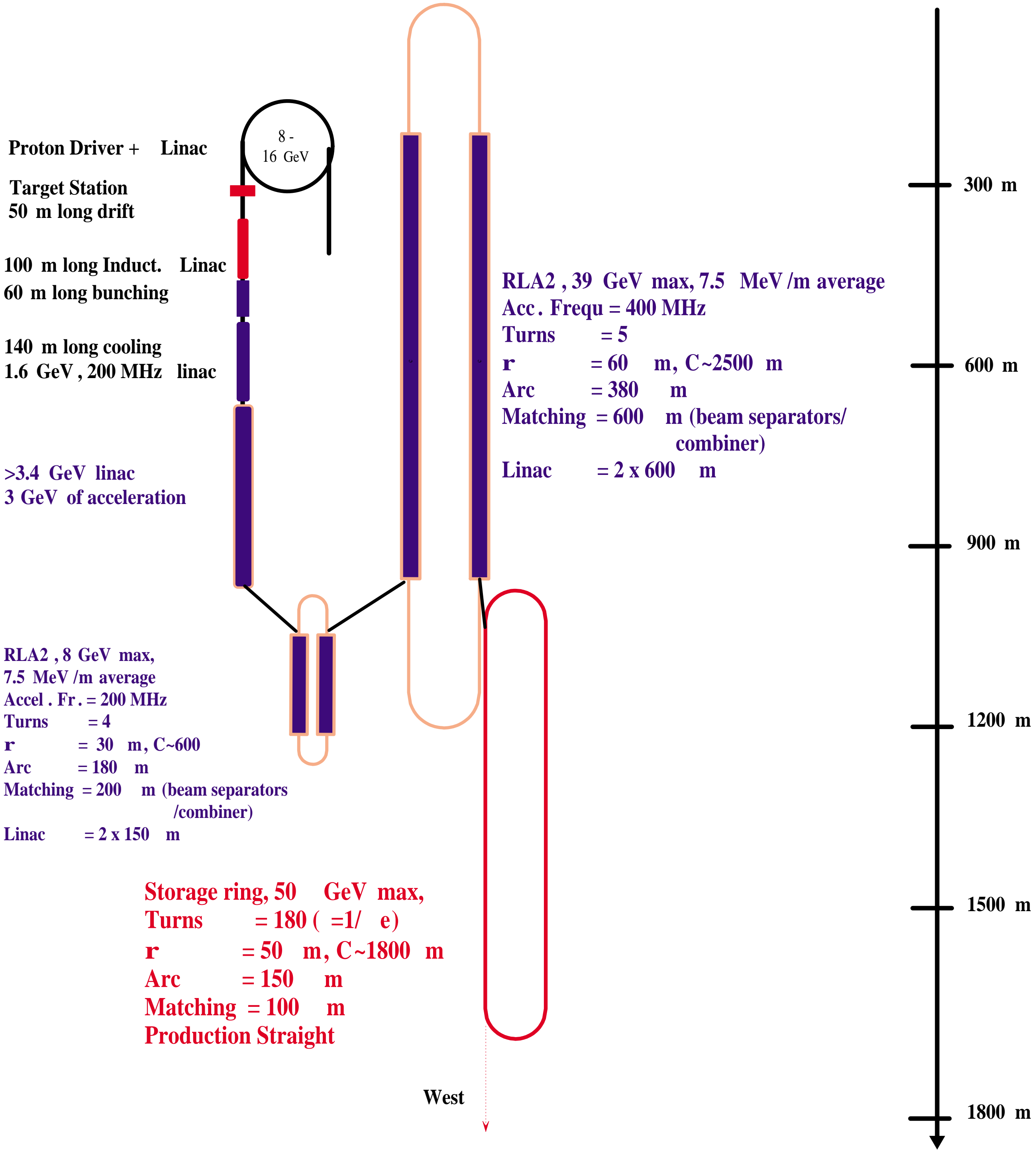
1. Energy of the Storage Ring should be 50 GeV
2. Number of neutrinos/straight section is  $2 \times 10^{20}$  per year
3. No polarization
4. Capability to switch between  $\mu^+$  and  $\mu^-$
5. Baseline for facility Fermilab to SLAC/LBNL

Table 1: Set of parameters chosen for the feasibility study following a very early assessment of the goals for the physics study.

1. Given the ongoing study at Fermilab for a fast cycling proton synchrotron (15 Hz) with 16 GeV extraction energy, the number of protons per pulse required on target is at least  $2 \times 10^{13}$ . This as approximately 1 MW beam power on target.
2. The transverse emittance of the muon beam after the cooling channel has to be small enough, in order to have the beam divergence in the straight section to be less than 1/10 of the decay angle, which is  $1/g = 2$  mrad. Given an invariant emittance of  $\epsilon = 3.2 \text{ pm} \times \text{rad}$  the  $\beta$ -function would be  $\sim 400$  m. This seemed reasonable.
3. Following the assumption of having ten protons per one muon injected in the storage ring,  $2 \times 10^{12}$  muons per pulse are required after the cooling channel and have to be accelerated.
4. No polarization.
5. The Neutrino beam is directed from Fermilab to SLAC/LBNL with a distance of  $\sim 3000$  km. This sets the slope of the storage ring with respect to the earth surface at 22% or 13 deg. Gentle enough to think of conventional installation methods.

Table 2: Specifications for the accelerator complex of the neutrino source.





	<b>PRESENT</b>	<b>(m-FACTORY) PHASE I</b>	<b>UPGRADE PHASE II</b>
<b>Linac</b> (operating at 15 Hz)			
Kinetic energy (MeV)	400	400	<b>1000</b>
Peak current (mA)	40	60	80
Pulse length ( $\mu$ s)	25	80	200
H <sup>+</sup> per pulse	$6.3 \times 10^{12}$	$3 \times 10^{13}$	$1 \times 10^{14}$
Average beam current ( $\mu$ A)	15	72	240
Beam power (kW)	6	29	240
<b>Pre-booster</b> (operating at 15 Hz)			
Extraction kinetic energy (GeV)			3
Protons per bunch			$2.5 \times 10^{13}$
Number of bunches			4
Total number of protons			$1 \cdot 10^{14}$
Norm. transverse emittance (mm-mrad)			$200\pi$
Longitudinal emittance (eV-s)			2
RF frequency (MHz)			7.5
Average beam current ( $\mu$ A)			240
Beam power (kW)			720
<b>Booster</b> (operating at 15 Hz)			
Extraction kinetic energy (GeV)	8	16	16
Protons per bunch	$6 \times 10^{10}$	$7.5 \times 10^{12}$	$2.5 \times 10^{13}$
Number of bunches	84	4	4
Total number of protons	$5 \cdot 10^{12}$	$3 \cdot 10^{13}$	$1 \cdot 10^{14}$
Norm. transverse emittance (mm-mrad)	$15\pi$	$60\pi$	$200\pi$
Longitudinal emittance (eV-s)	0.1	2	2
RF frequency (MHz)	53	1.7	7.5
Extracted bunch length $\sigma_b$ (ns)	0.2	3	1
Average beam current ( $\mu$ A)	12	72	240
Target beam power (kW)	<b>100</b>	<b>1200</b>	<b>4000</b>

**Proton Driver Parameters of Present, Phase I and Phase II.**

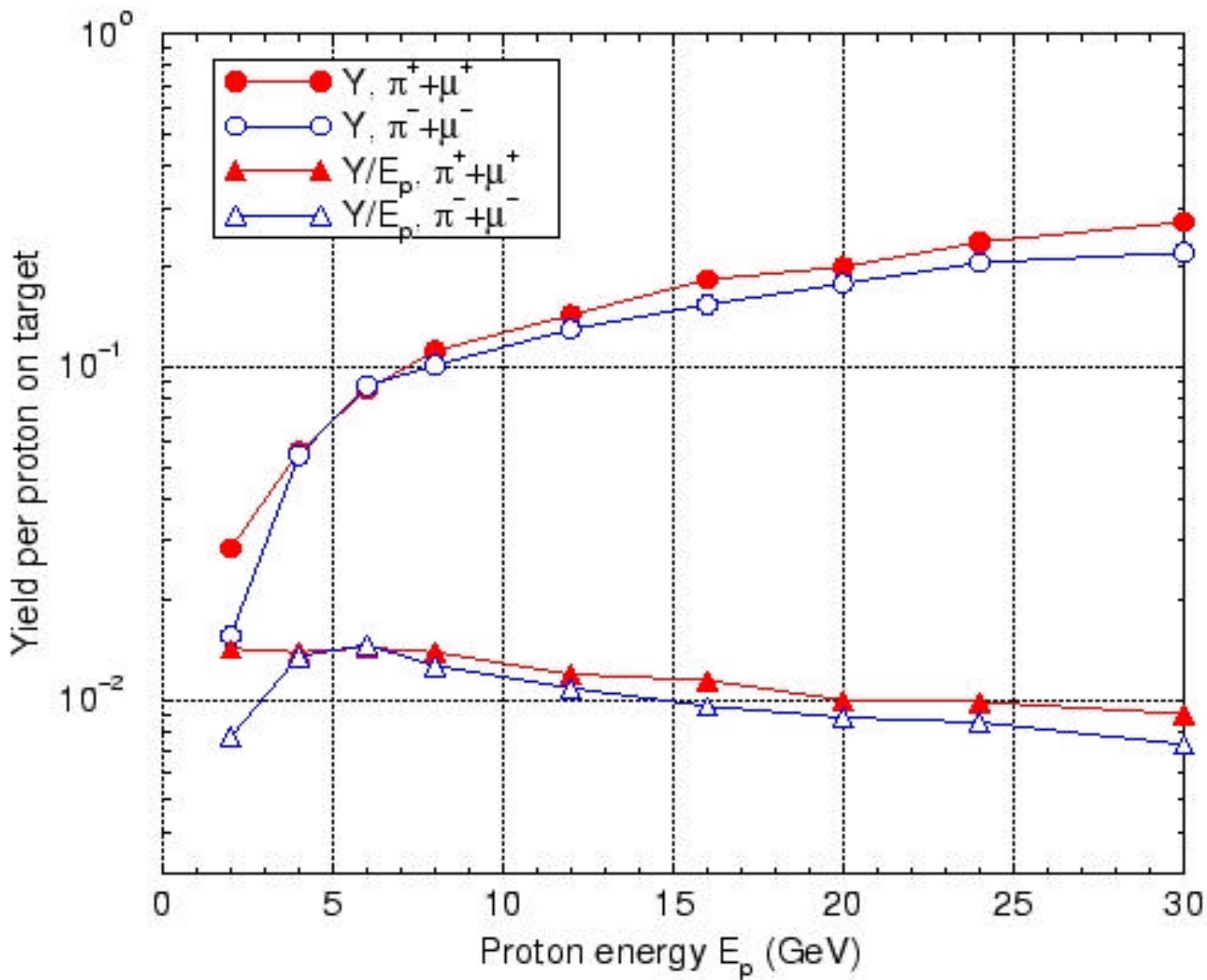


Figure 1: The number of  $\pi^+ + \mu^+$  (filled symbols) and  $\pi^- + \mu^-$  (open symbols) at  $30 \text{ MeV} < E < 230 \text{ MeV}$ , as a function of proton energy in the decay channel. Yields are at 9 m downstream of an 80-cm long and 0.75-cm radius carbon target, tilted by 50 mrad with respect to the solenoid axis. RMS beam spot size  $s_{x,y} = 0.214 \text{ cm}$ . Triangles represent the yield per beam energy



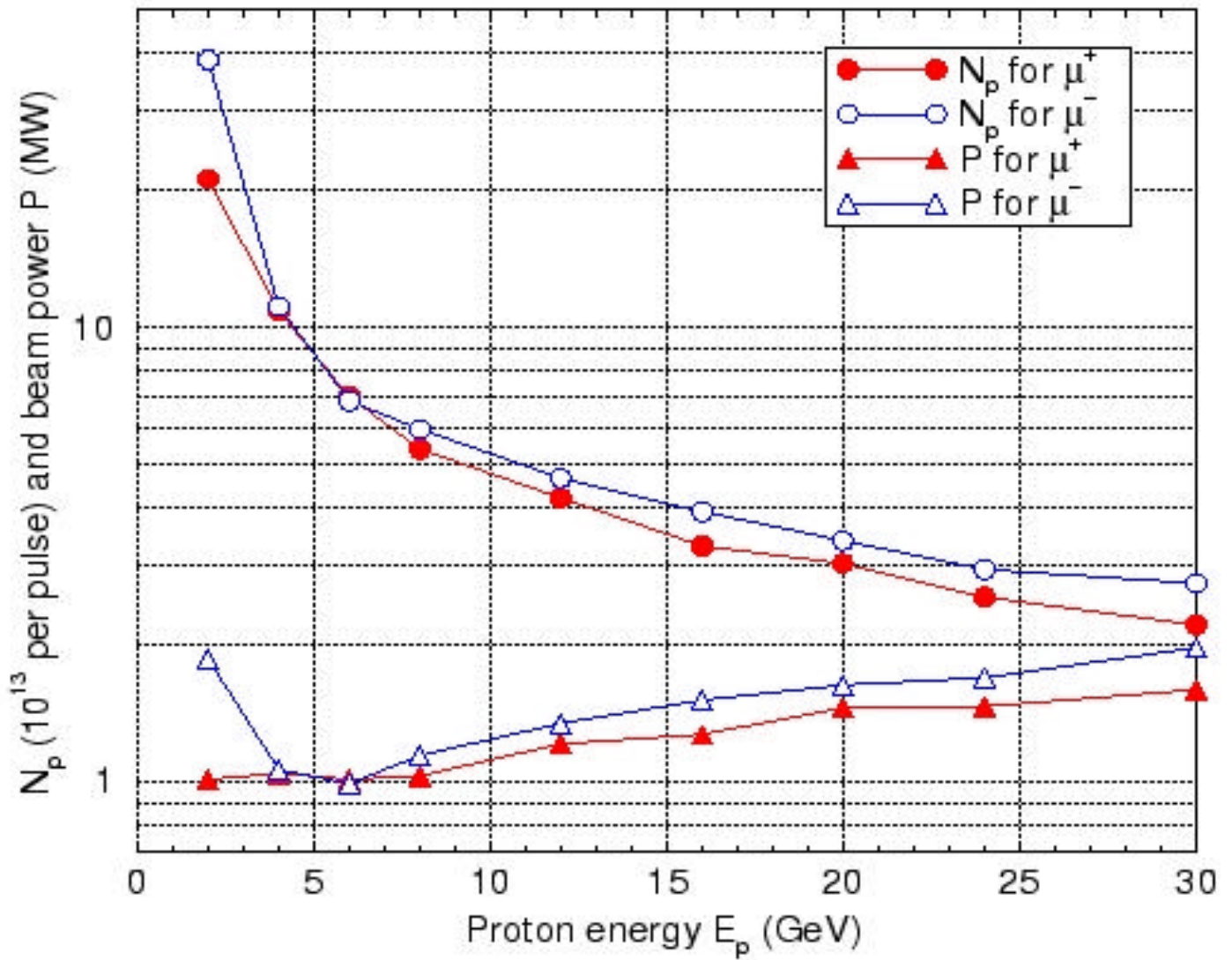
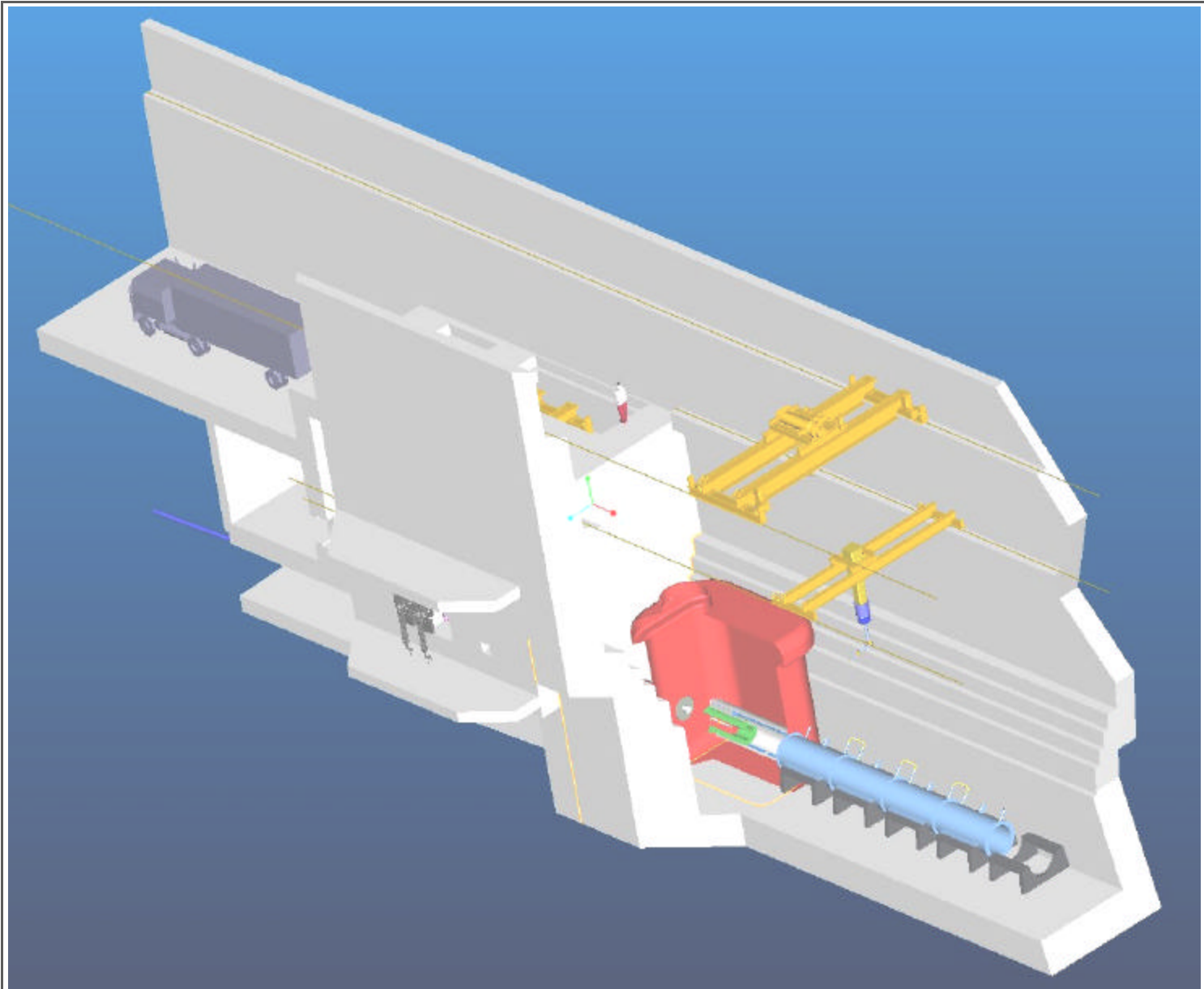


Figure 1: The number of protons per pulse on an 80-cm carbon target required to get  $2 \times 10^{20}$  positive (filled symbols) and negative (open symbols) muons per year in the storage ring straight section vs. proton energy. Triangles represent corresponding beam power.

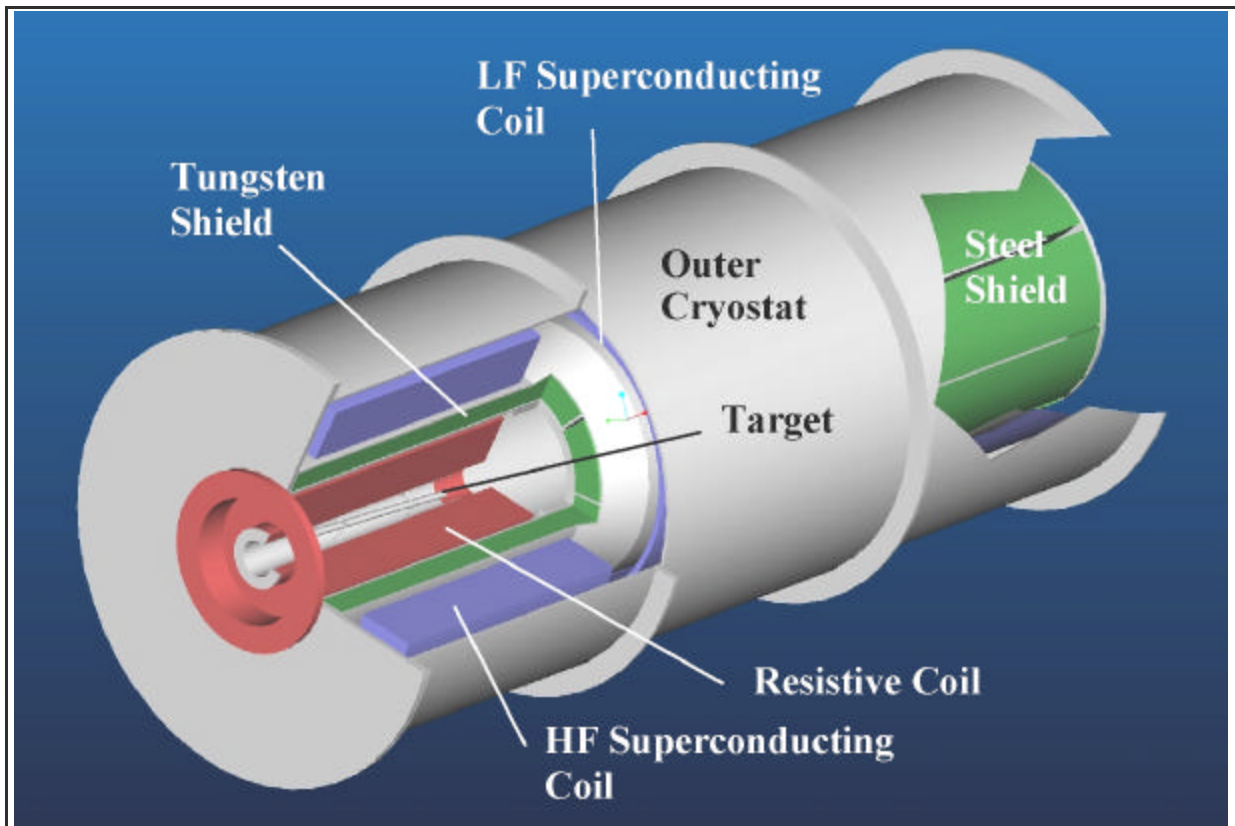
For a 1.5 MW beam, the annual hadron flux in a stationary graphite target is  $5 \times 10^{21} \text{ cm}^{-2}$ , which corresponds to several months of target lifetime. The annual hadron flux ( $E > 0.1 \text{ MeV}$ ) and dose in the hottest spot of the inner resistive coil are  $1.2 \times 10^{20} \text{ cm}^{-2}$  and  $3 \times 10^{10} \text{ Gy}$ , respectively. This corresponds to ~3 year lifetime limit for copper and ceramic. As discussed later, other considerations also severely limit the lifetime of the resistive coil. The annual neutron flux ( $E > 0.1 \text{ MeV}$ ) and the dose in the hottest spot of the high field superconducting coil are  $8 \times 10^{17} \text{ cm}^{-2}$  and  $1.3 \times 10^7 \text{ Gy}$ , respectively, or 15 to 20 year lifetime. The annual neutron flux ( $E > 0.1 \text{ MeV}$ ) and dose in the hottest spot of the potted superconducting coil at the beam dump are  $7.6 \times 10^{17} \text{ cm}^{-2}$  and  $4.1 \times 10^7 \text{ Gy}$ , respectively, or 7-10 year lifetime with the current shielding. The lifetime numbers are rather uncertain, due to lack of data for radiation damage to superconducting materials at neutron energies above 14 MeV. With better understanding of these effects, a shielding design can be adapted that provides longer coil lifetime.

Residual dose rates for a 1.5 MW beam are up to  $10^7 \text{ mSv/hr}$  ( $10^6 \text{ R/hr}$ ) on the target, bore tube and inner resistive coil,  $10^3 \text{ mSv/hr}$  ( $100 \text{ R/hr}$ ) on the CICC (cable-in-conduit conductor) coil and  $10^2 \text{ mSv/hr}$  ( $10 \text{ R/hr}$ ) on the vessel, with the requirement for remote control and robotics. Radiation shielding requirements based on these rates are presented as part of the target support facility design.

We have chosen to design with poly-Bitter technology, which is highly developed, capable of very high current densities, and subjects the insulation to predominantly compressive stress. However, the life-time of poly-Bitter magnets is limited (in designs appropriate for the present application, primarily by water erosion of insulating materials and degradation of electrical contacts).



**Figure 1.** Overview of the Target Support Facility.



**Figure 1.** Cutaway view of the high-field solenoid, target, and shielding in the cryostat module.

Component	Expected Lifetime	Replacement Time
Target	3 mos	6 days
Target + Bitter Coil	<b>6 mos</b>	7 days
Target +Bitter Coil + PBW	1 yr	8 days
PB Instrumentation	1 yr	5-7 days
Beam Dump	5 yrs	1.5 mos
High Field S/C Coils	>20 yrs	9-12 mos
Low Field S/C Coils	>20 yrs	9-12 mos

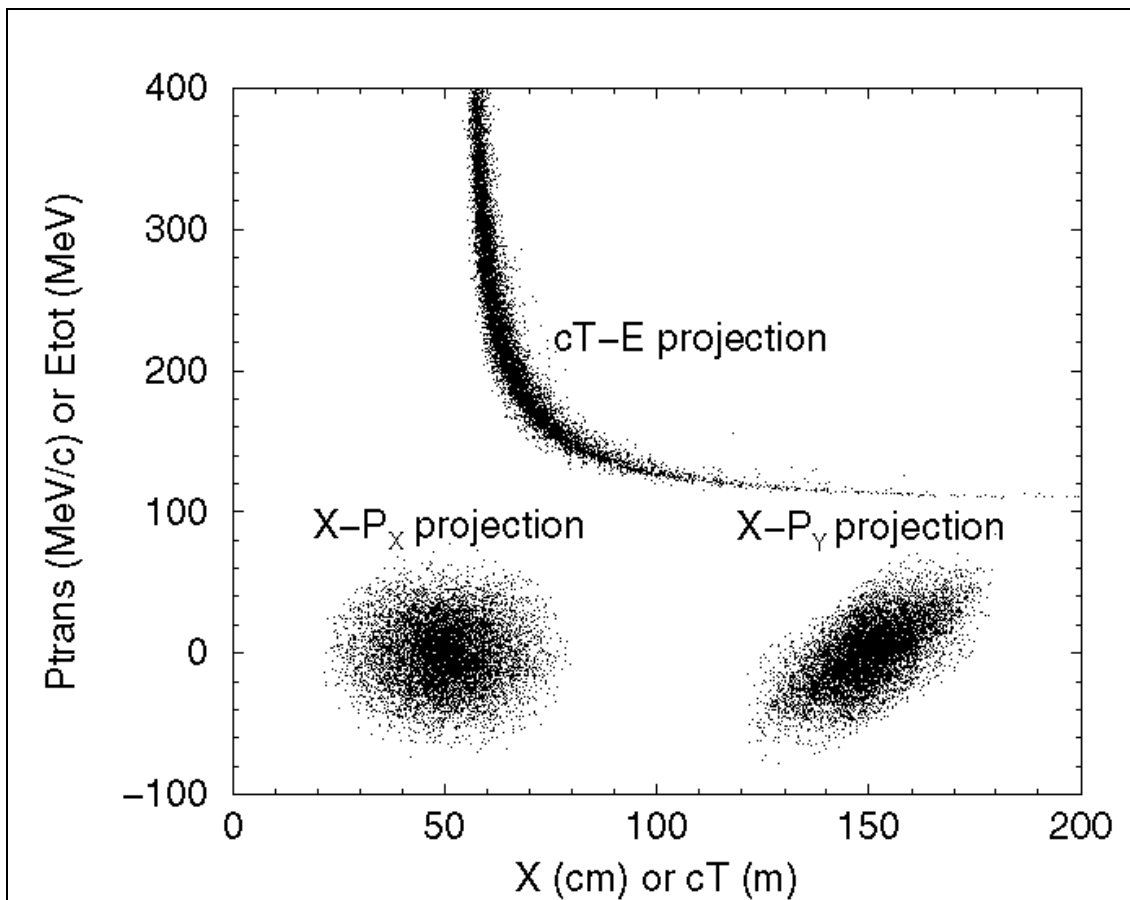
**Component Lifetimes for the Target Support Facility**

Region	Position m	$p+m$ /proton	E-window MeV	$e_{t,n}$ (mm)	$s_x$ (m)	$s_{px}$ (MeV/c)
After Target	0	0.242	<500	15.1	0.090	23.0
Decay Channel	47	0.226	<500	15.9	0.092	22.5
Matching (D)	50	0.222	<500	16.5	0.057	34.2
Induction Linac	150	0.191	<450	16.3	0.060	44.9
“Mini-Cool”	153.4	0.191	<375	12.6	0.055	32.6
Buncher (all $m$ s)	170.9	0.188	<375	12.4	0.046	32.2
Buncher (in bucket)	170.9	0.123	In bucket	12.0	0.046	31.4

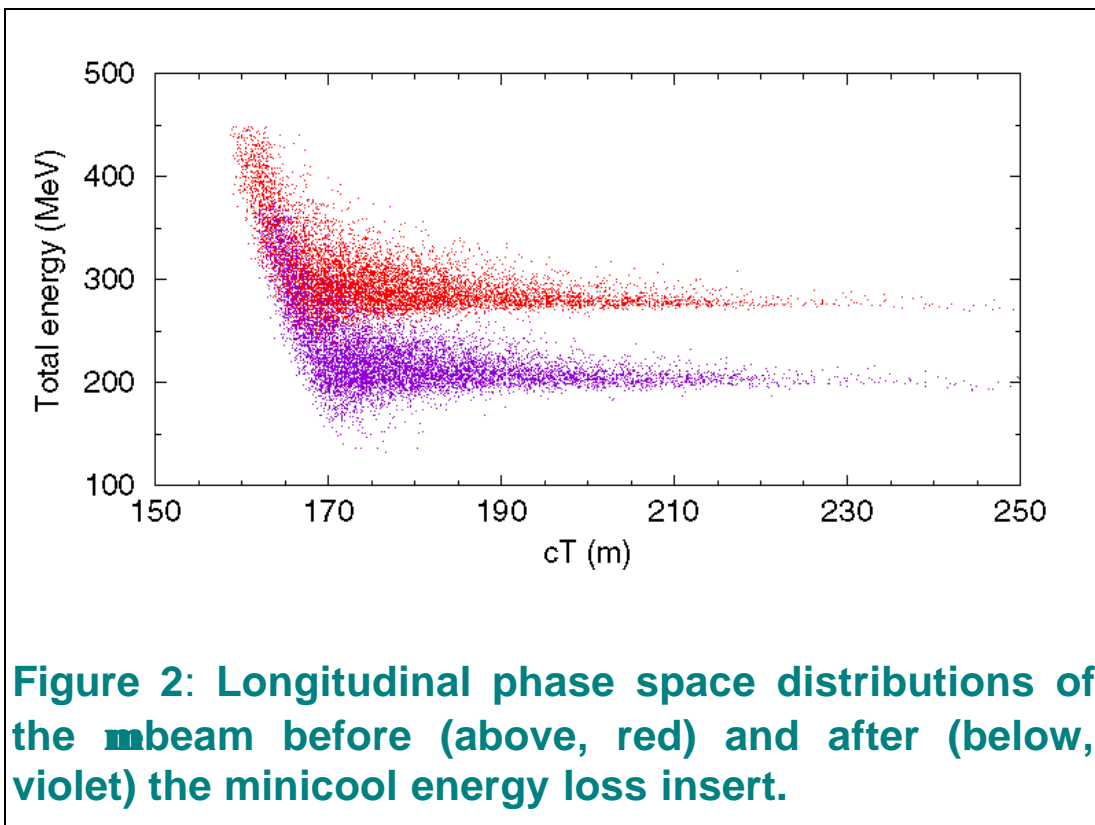
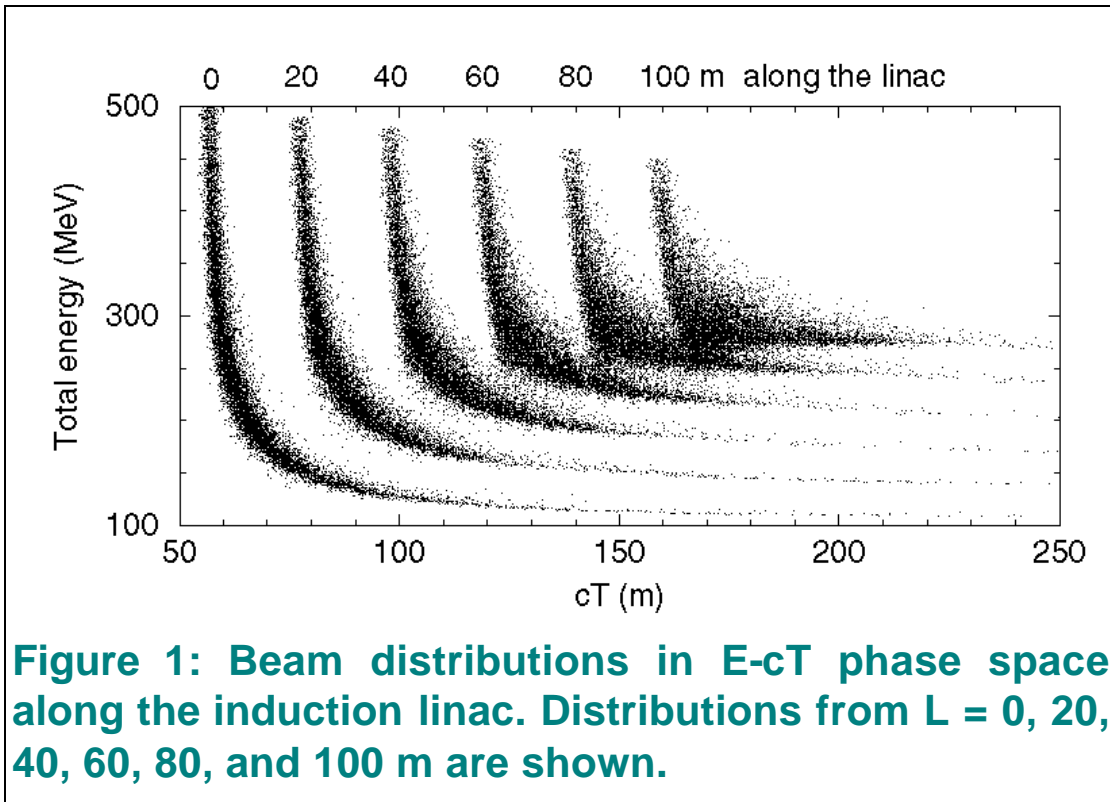
**Table 1: Beam Properties along the Capture and Bunching Section.**

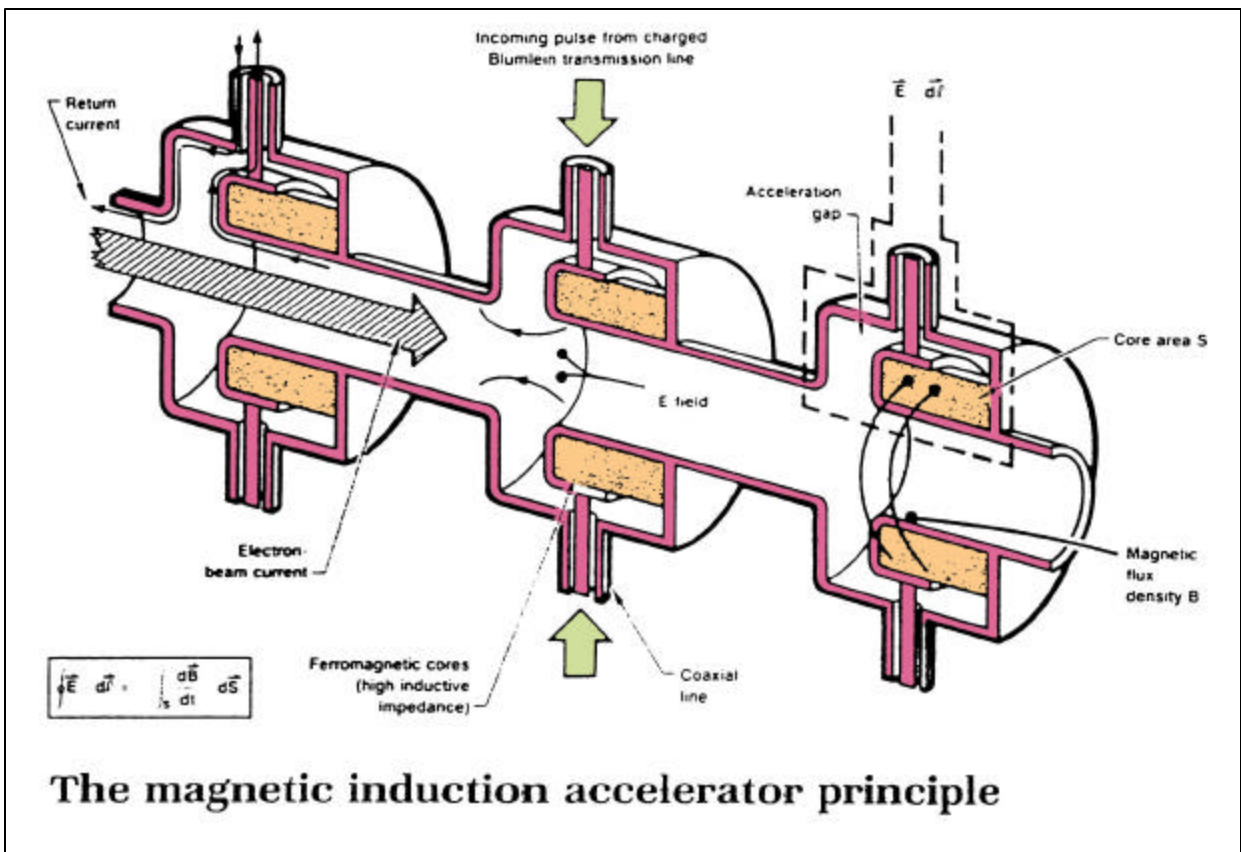
The precooling decay, RF capture and buncher decay channel follows the target and capture solenoid. This channel is matched into an induction linac phase-energy rotation system (100m long), which is followed by a “minicool” energy absorber (2.45m of liquid hydrogen), and a bunching section (16.4m long) matching the beam into a 201.25 MHz cooling system. Simulation results are displayed in Table 1.

**A critical parameter for this channel is the total voltage difference that can be provided by the induction linac, since that also determines the energy range which can be accepted by the capture system.** Our baseline scenario contains a voltage difference of 200 MV (+150 to –50 MV). With that range, we can accept the  $p^{\oplus}m$  particles with energies centered about the maximal production energy of ~130 MeV kinetic energy.

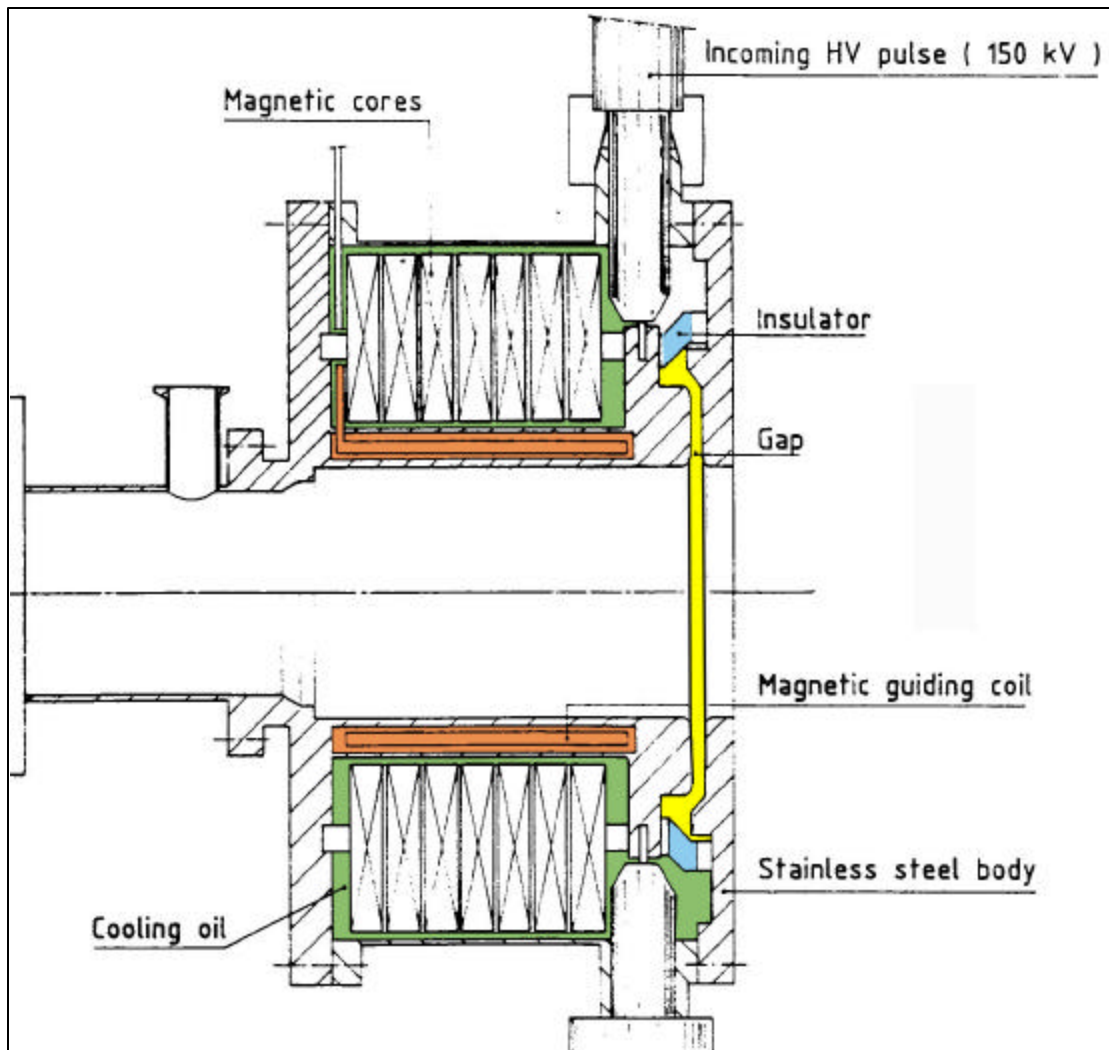


**Figure 1: Beam at the end of the 47 m decay channel. Three projections of the 6-D phase space distributions of a simulated beam are displayed. The cT-E projection shows the energy-dependent bunch lengthening. The X- $P_x$  projection indicates the beam phase-space size ( $s_x$  @ 9 cm,  $s_{p_x}$  @ 22 MeV/c). The X- $P_y$  projection indicates the beam angular momentum associated with the 1.25T solenoidal focusing field.**

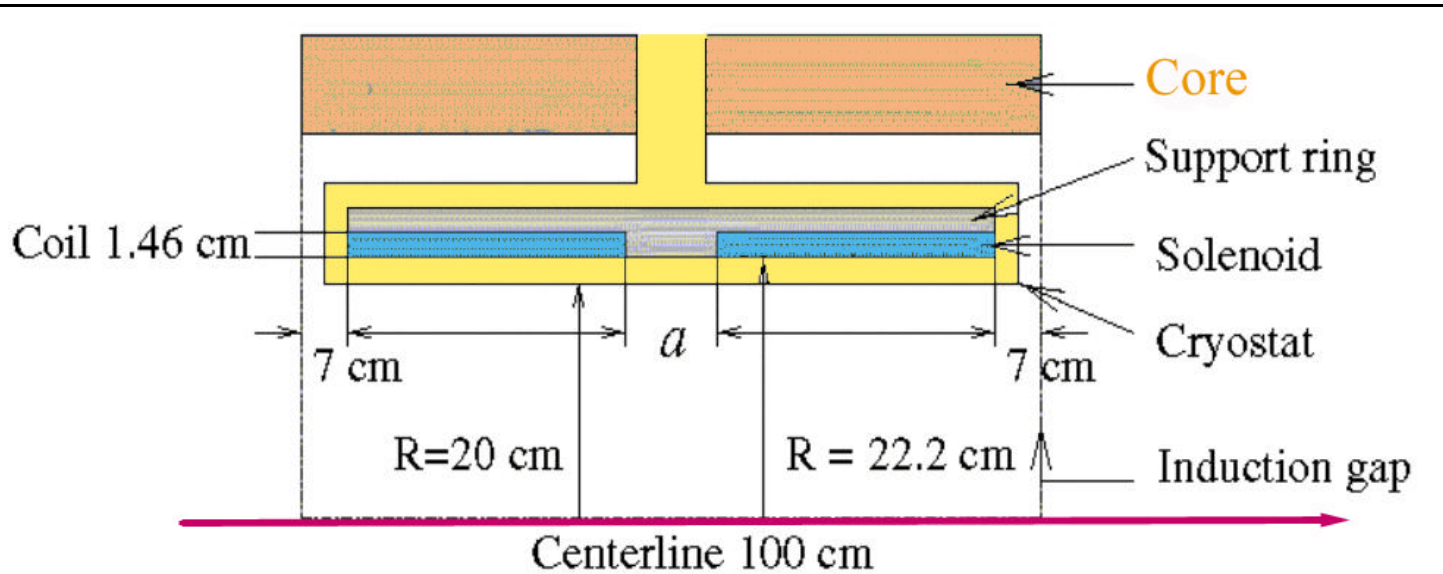




**The magnetic induction accelerator principle**

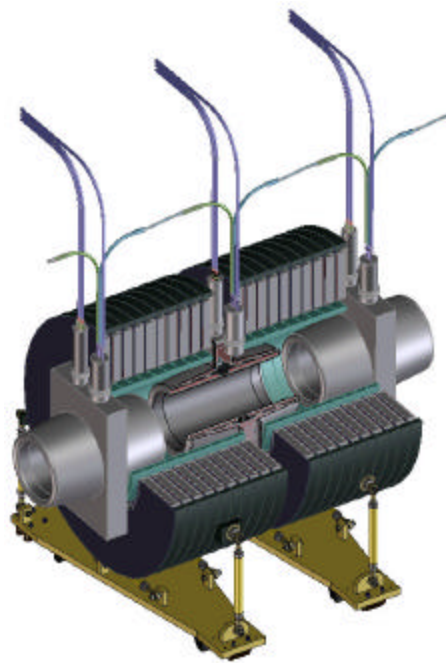
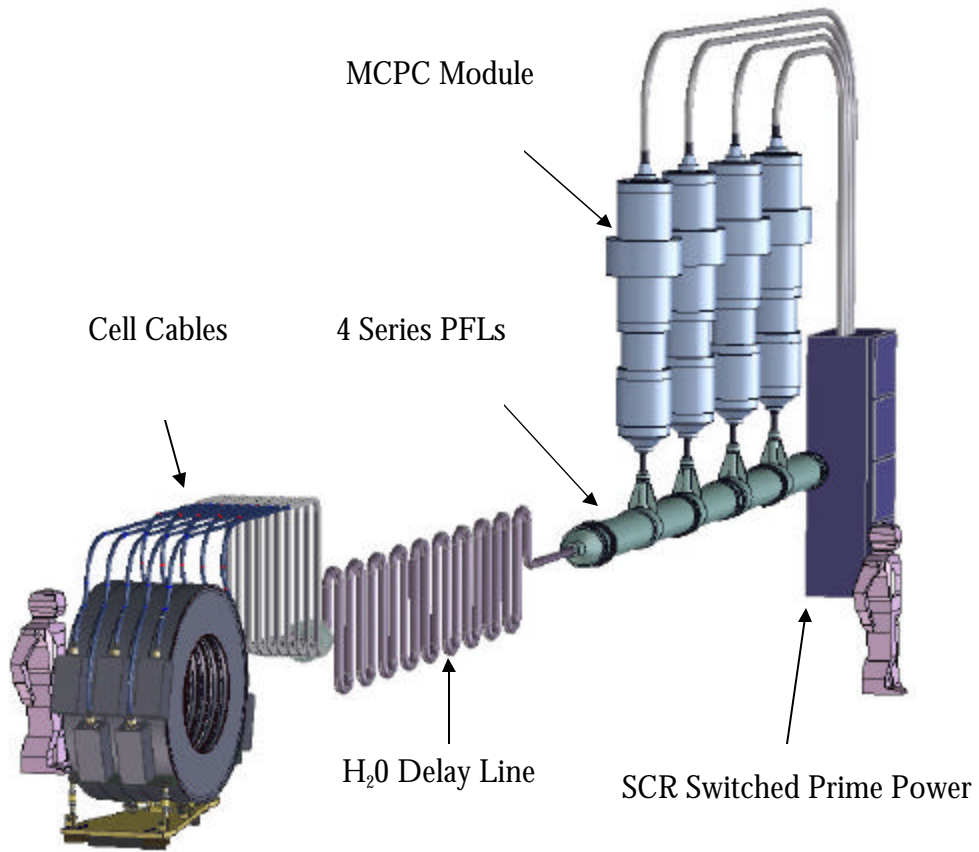


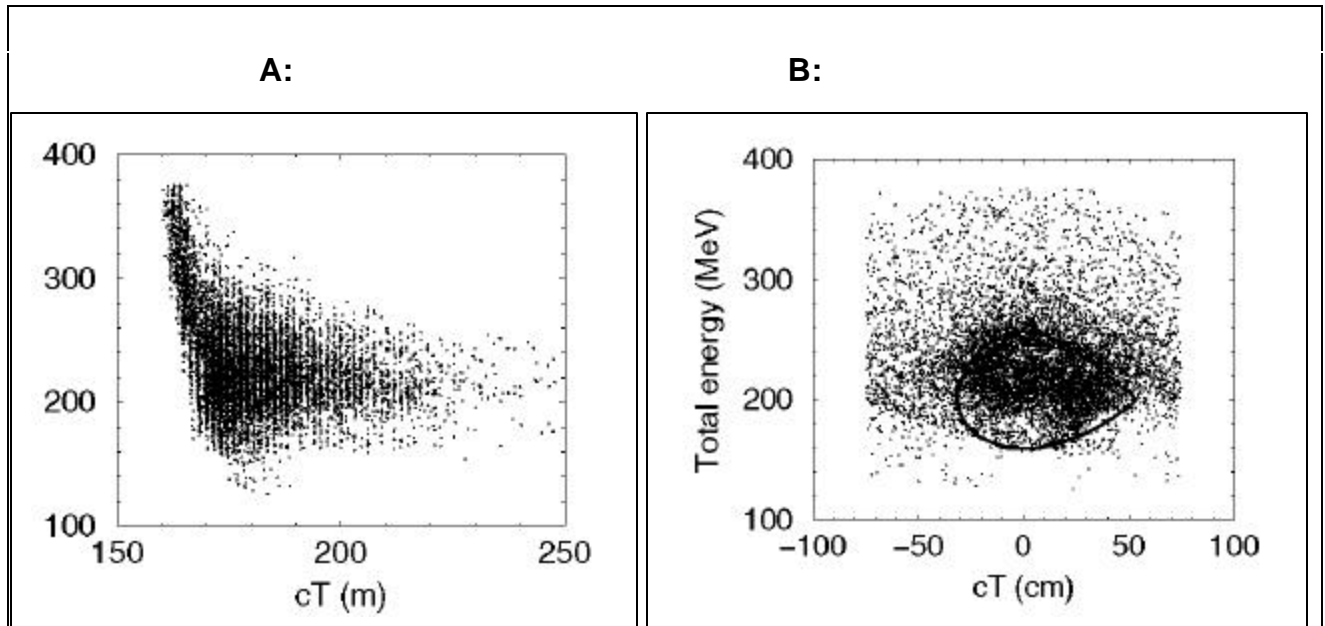




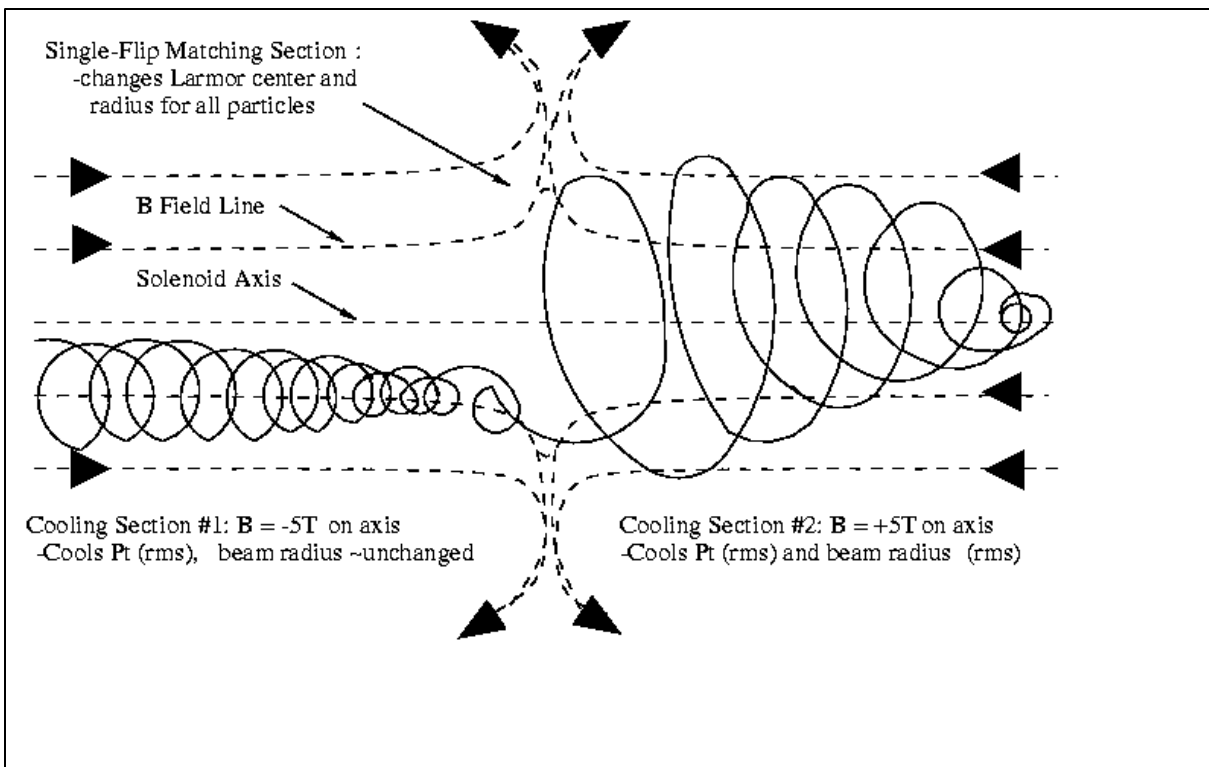
**Figure 1:** Schematic cross section of an induction linac cell.

## Pulsed Power System layout and Induction Cell



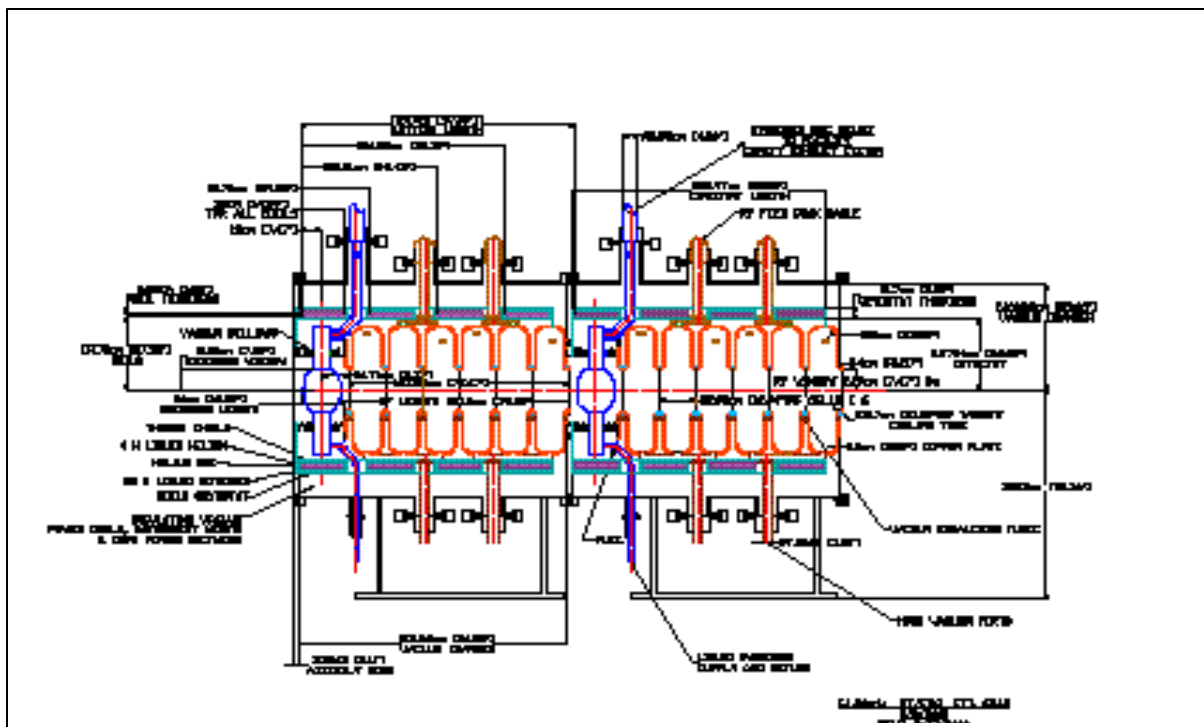


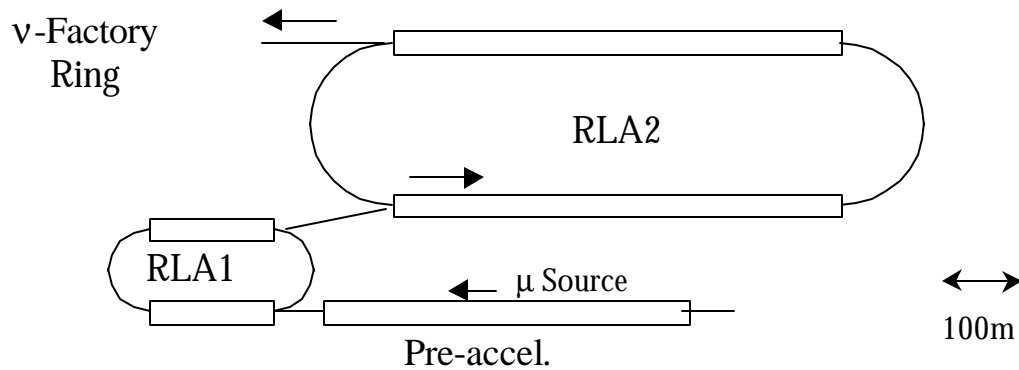
**Figure 1: Beam distributions in energy –distance coordinates. A shows the full beam length; B shows the distribution folded over the 201.25 MHz periodicity, with an RF bucket for 200 MeV, 200 MHz cooling.**



### Illustration of particle motion in a single flip channel

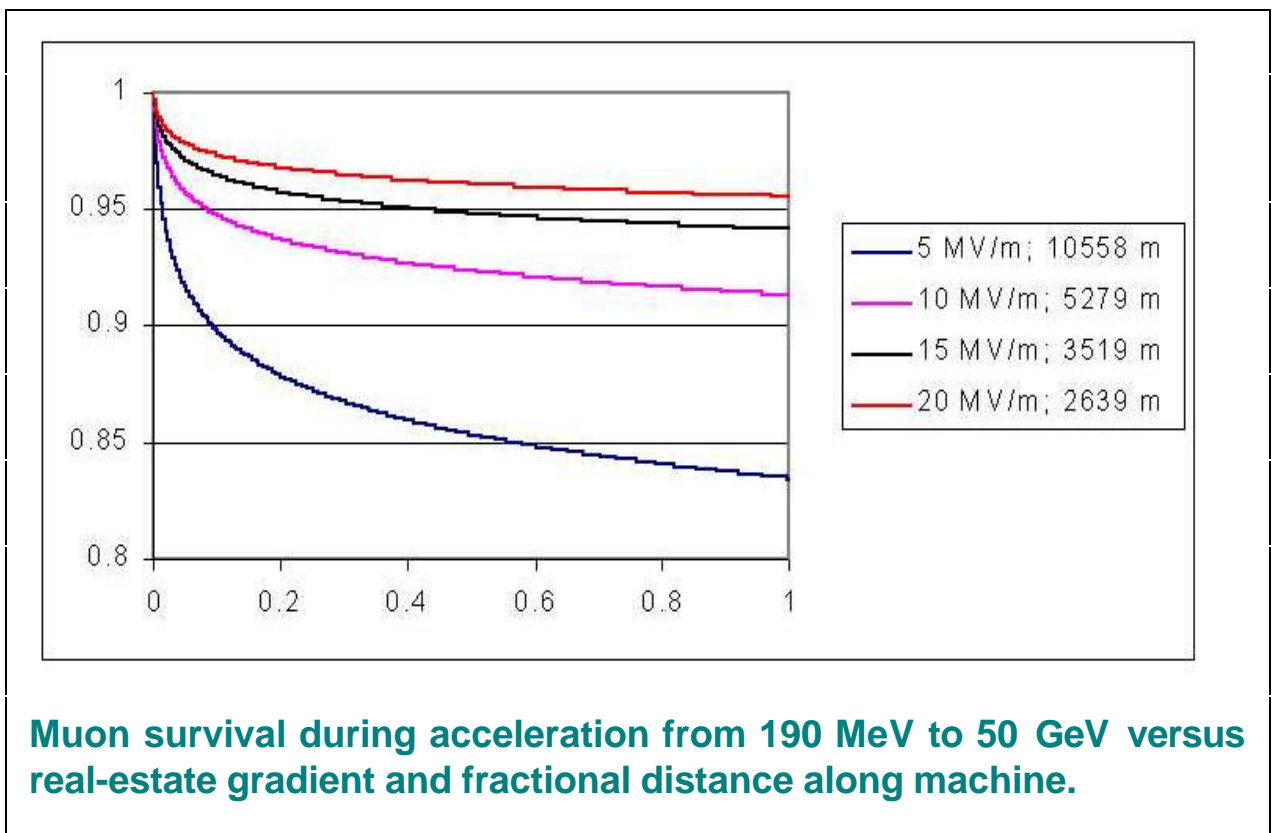
While both designs have adequate performance for an entry-level neutrino factory, both fall short of the PJK benchmark. In both cases, the performance of the cooling channel is limited by the parameters of the input beam provided at the end of the buncher. We expect that ongoing work on tuning and optimization will improve the muon yield by a substantial factor.





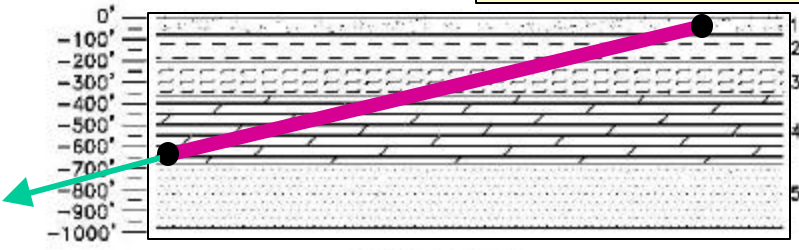
## Acceleration Issues

- muon survival,
- choice of accelerating technology and frequency,
- accelerator acceptance – capture, acceleration, and transport of the large muon phase space, and
- accelerator performance – issues such as potential collective effects (e.g., cumulative beam breakup) resulting from the relatively high peak current during the muon macropulse.



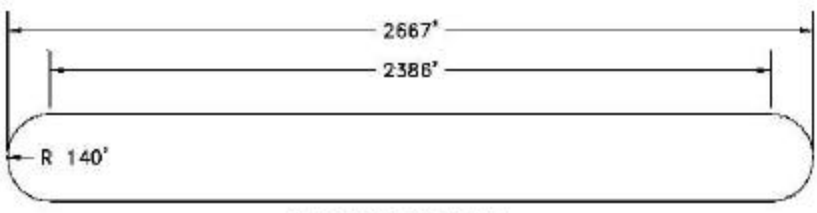
Circumference	m	1752.8
Neutrino decay fraction	%	39.2
<b>Production region</b>		
Matching and dispersion suppression	m	44.1
High-beta FODO straight	m	688
<b>General</b>		
$\beta_x(\text{max})/\beta_y(\text{max})$		90
$v_x/v_y$		86.3
Natural chromaticity		12

**Overall parameters of the storage ring.**



**GEOLOGY DETAIL**  
1"=100'

- 1. GLACIAL TILL - AQUIFER
- 2. SILURIAN GROUP - AQUIFER (PRIMARILY DOLOMITE)
- 3. MAQUOKETA GROUP - AQUIFER (PRIMARILY SHALE)
- 4. GALENA / PLATTEVILLE GROUP - AQUIFARD (PRIMARILY DOLOMITE)
- 5. ANCEL GROUP - AQUIFER (PRIMARILY SANDSTONE)



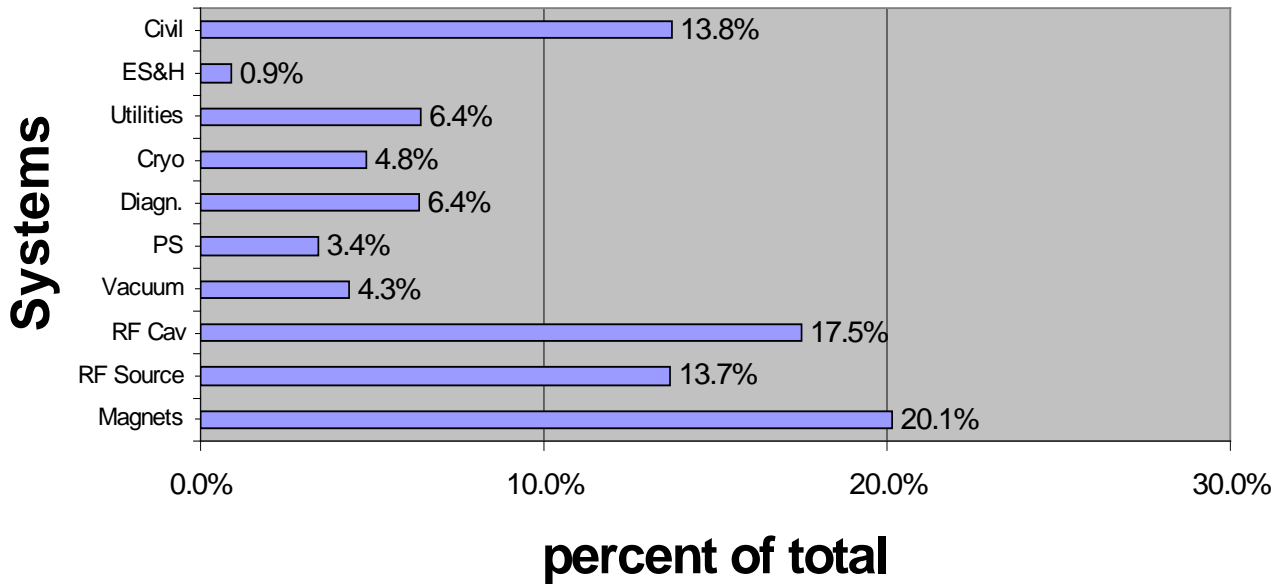
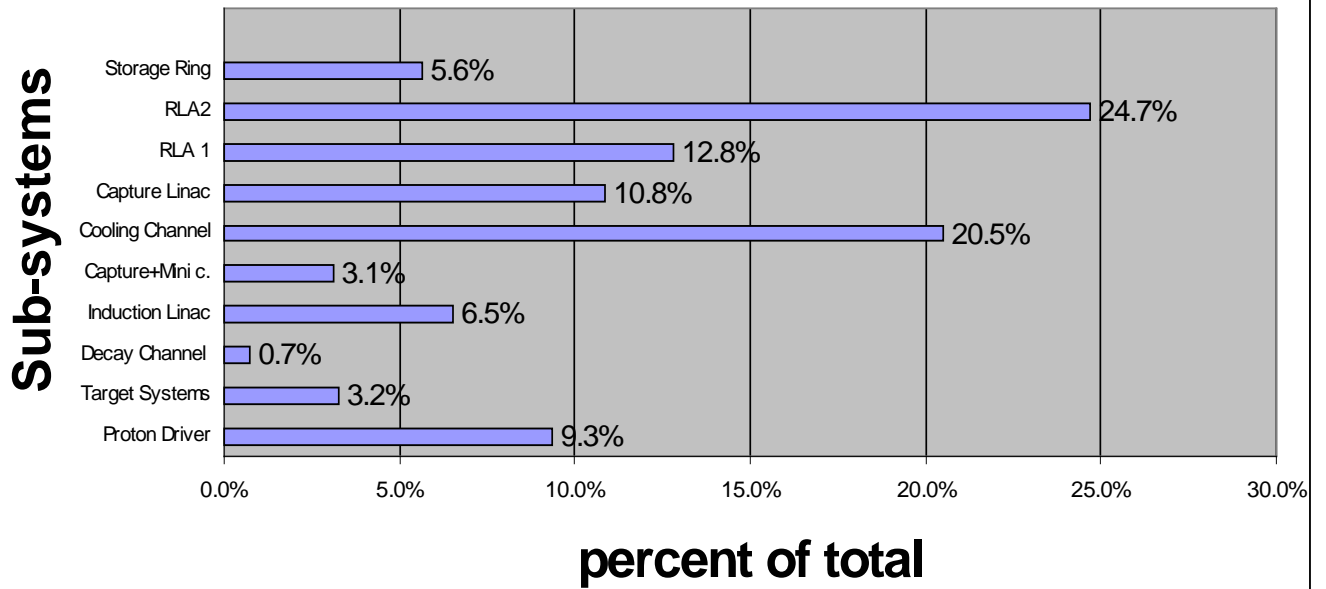
**CE 2.1 LATTICE PLAN**  
1/8"=1'

<b>ORIENTATION:</b>		
NAME	AZIMUTH (DEG-MIN-SEC)	VERT. ANGLE (DEG-MIN-SEC)
PALO ALTO CA.	271-20'-42.27"	-13-09'-26.99"



Constraints on the storage ring due to the geology under the Fermilab site. The 2667' (or 813 meter) limit on the cross-section profile of the ring shown in the lower drawing is given by the 600 foot available for the ring's vertical drop the and 13 degree angle between Fermilab and the West Coast.

### Cost Total for each Sub-System



Distribution of cost in percent of the total for the different subsystems and for the components summed up over the subsystems.