

Pion collection solenoid

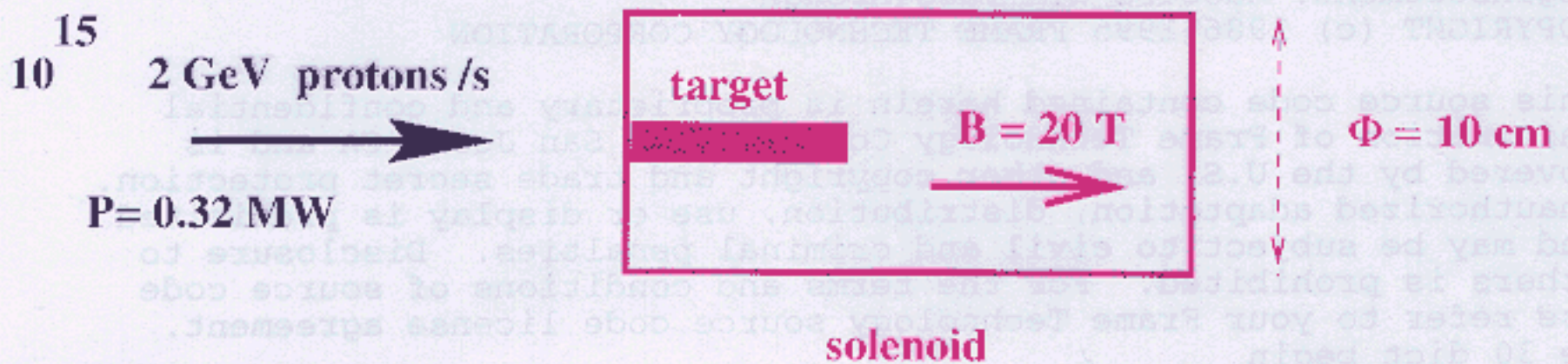

Capture of pions with :

$$P_t(\text{GeV}) \leq \frac{\Phi(\text{m}) B(\text{T})}{13.3} = 0.15 \text{ GeV}$$

SC or Resistive Solenoid?

SC solenoids:

	$T_c(0\text{ T})$	$T_c(11\text{ T})$	$\mu_0 H_{c2}(T=0\text{ K})$	$\mu_0 H_{c2}(T=1.8\text{ K})$	$\mu_0 H_{c2}(T=4.2\text{ K})$
NbTi	9.5 K	4.2 K	14 T	14 T	11 T
Nb ₃ Sn	18 K	10.4 K	25.5 T	25.5 T	23.2 T

Nb₃Sn: 21 T solenoids commercially available
but $\phi \leq 50\text{ mm}$, $l \leq 50\text{ cm}$

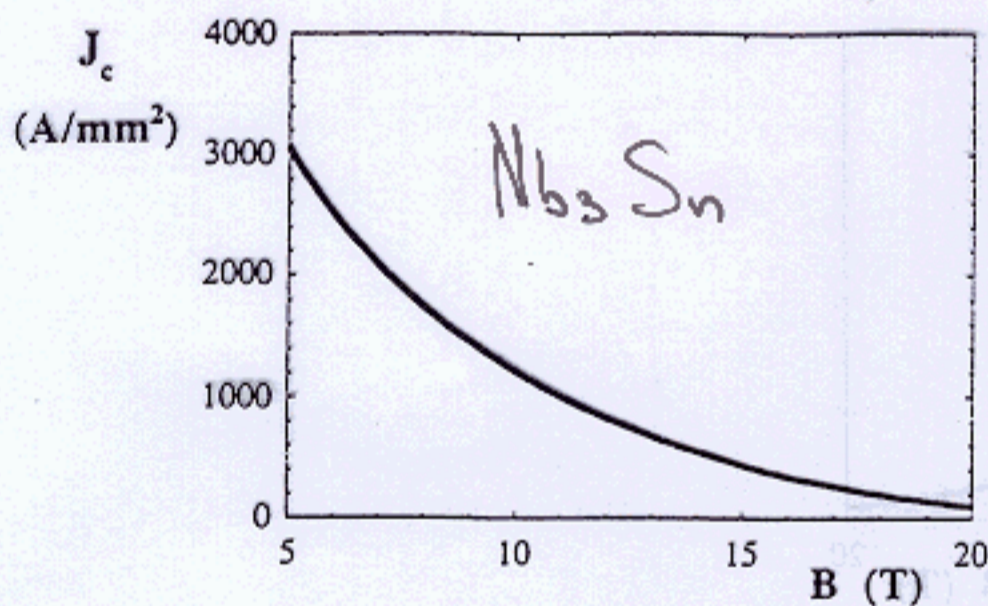

NbTi: B_c too low!
could be used in a hybrid magnet -
8 T, $\phi = 800\text{ mm}$

⚠ Radiation tolerance

Resistive solenoids:

- no field limit
- need high electrical power ($\geq 10\text{ MW}$)
- limited in practice by cost of D.C. power supply & cooling system
- radiation hard (Cu, kepton)

Grenoble High Magnetic Field Lab

- Founded in 1992

- jointly operated by Max Planck Institut (Stuttgart)
& CNRS

	Magnetic Field Strength T	Bore diameter mm	Power MW	Magnet type (from the inner to the outermost)	Remarks
M1		50	10		Test site
M2	17	50	10	1 Bitter magnet	Magnet with four radial accesses for optical purposes. Field axis horizontal.
M3	27 24	34 50	10 10	Double helix + 2 Bitter magnets	Radially cooled helices
M5	20 13 6	50 130 286	10 10 5	1 internal Bitter magnet + 2 outer Bitter magnets	
M6	24	50	10	Double helix + 2 Bitter magnets	Radially cooled helices
M7	20	50	10	2 Bitter magnets	
M8	30 30 20 10	50 50 130 400	10 10 10	12 helices + 2 Bitter + 1 superconducting magnet 10 helices + 2 Bitter + 1 superconducting magnet 2 Bitter + 1 superconducting magnet 1 superconducting magnet	Hybrid magnet World record in 1987 31.3 T in 50 mm To be dismantled in summer 1998 and replaced by the new hybrid magnet.
M9	22	50	10	12 helices + 2 Bitter magnets	Field axis vertical or horizontal.
M10	34 30 20 10	34 50 130 376	20 20 10 10	20 helices + 2 external Bitter magnets 10 helices + 2 Bitter + 2 external Bitter magnets 4 Bitter magnets 2 external Bitter magnets	Operational 6/98 Operational 10/98

New hybrid magnet under construction :

SC part } NbTi 8T $\phi = 800$ mm L=1m
 } T=1.8K

max. Field 41.6T } within $\phi = 34$ mm
 } For 24 MW.

Proposals

Made under guidance of Walter Joss from GHMFL

Bitter magnet:

$L = 3 \text{ m}$

$\Phi_r = 800 \text{ mm}$

$B = 20 \text{ T}$

$\Phi_i = 100 \text{ mm}$

Cu

$P = 60 \text{ MW}$

Hybrid magnet:

$L = 3 \text{ m}$

$\Phi_r = 800 \text{ mm}$

$B = 12 \text{ T}$

$P = 22 \text{ MW}$

$\Phi_i = 100 \text{ mm}$

Cu

Understanding the resistive solenoid features

Magnet simplified model

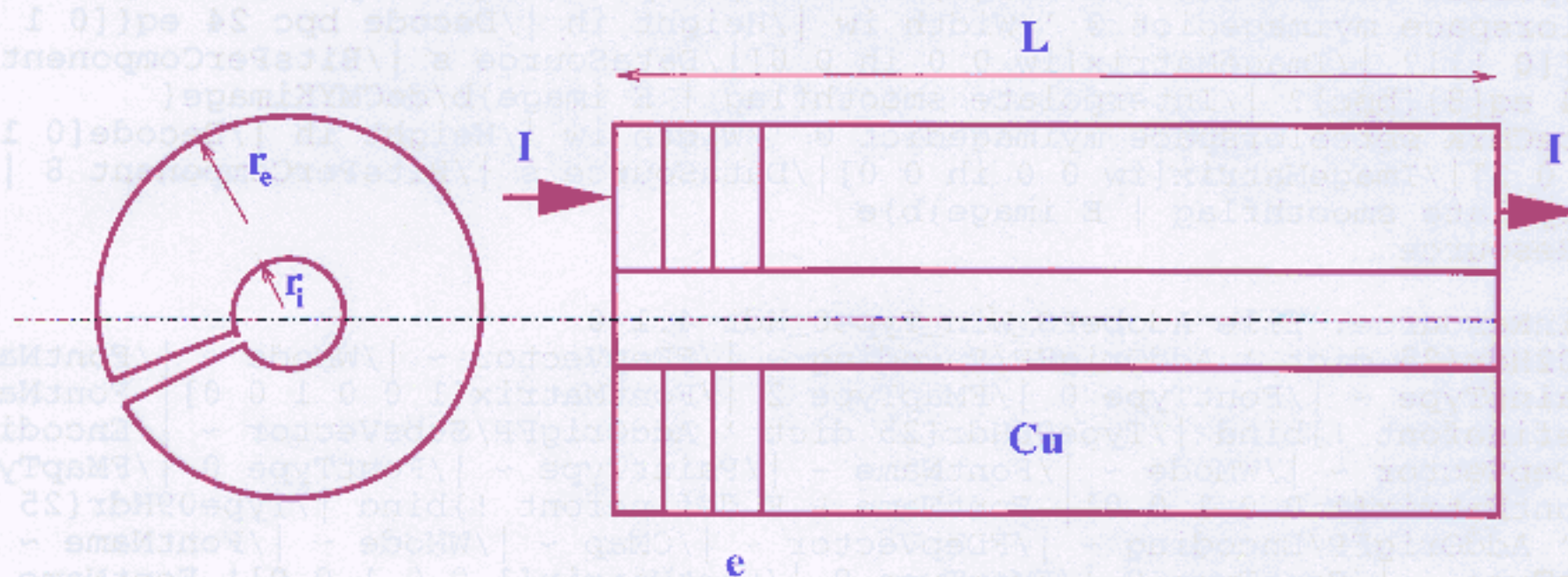

$$B = \mu_0 NI \quad N \text{ number of windings or turns per m}$$

$$NI = 0.8 B(T) \text{ (MA turns/m)}$$

$$I=16 \text{ kA} , \quad B=20 \text{ T} \quad \text{then } N=1000 \text{ turns/m} \rightarrow e=1\text{mm}$$

$$R/\text{turn} = \left(\int_{r_i}^{r_e} \frac{1}{\rho} \frac{e}{2\pi r} dr \right)^{-1} = \frac{2\rho\pi}{e} \frac{1}{\ln(r_e/r_i)}$$

$$\text{Power: } P = R.N.L I^2$$

$$\text{Field: } B = \mu_0 \sqrt{\frac{N.P}{R.L}}$$

$$B = 20 \text{ T} , e = 1 \text{ mm} , r_i = 5 \text{ cm}$$

$$r_e = 25 \text{ cm} , \rho = 2.1 \cdot 10^{-8} \Omega \text{ m}$$

$$R/\text{turn} = 82 \mu\Omega \rightarrow P = 63 \text{ MW}$$

$$(1 \text{ TGJ} = 6 \text{ MW})$$

$$\text{If } P = 20 \text{ MW} \rightarrow B = 11.3 \text{ T}$$

Cooling

Water
2-10 M Ω cm

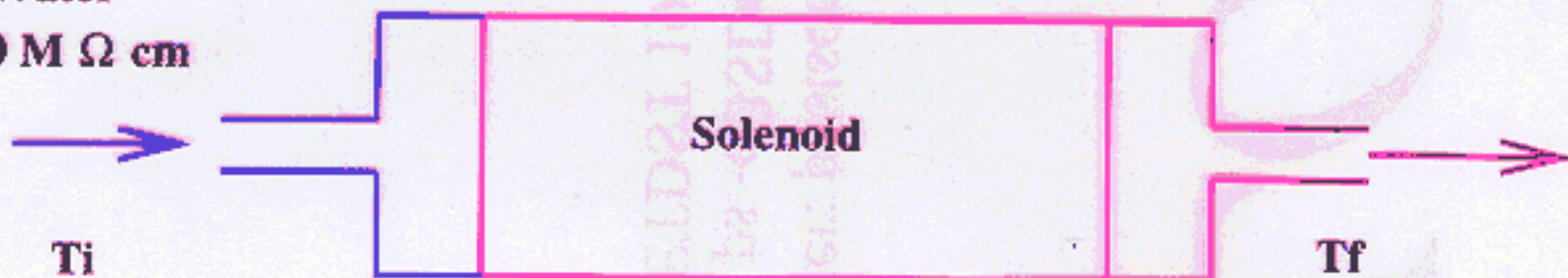

$$\Delta T = T_f - T_i = 20 \text{ K}$$

$$V = \frac{63 \cdot 10^6}{4.18 \times 1000 \times 20} = 750 \text{ l/s}$$

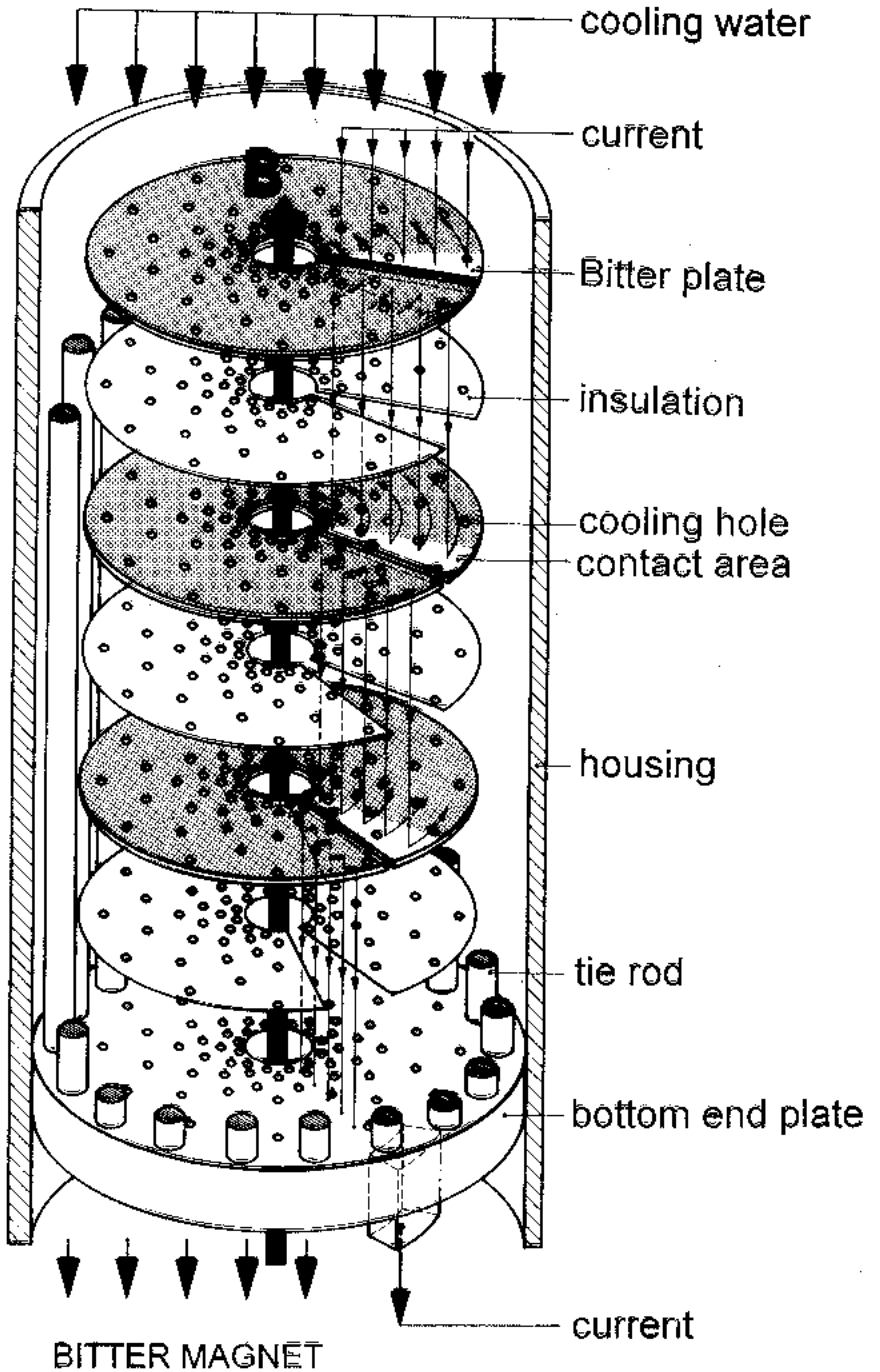

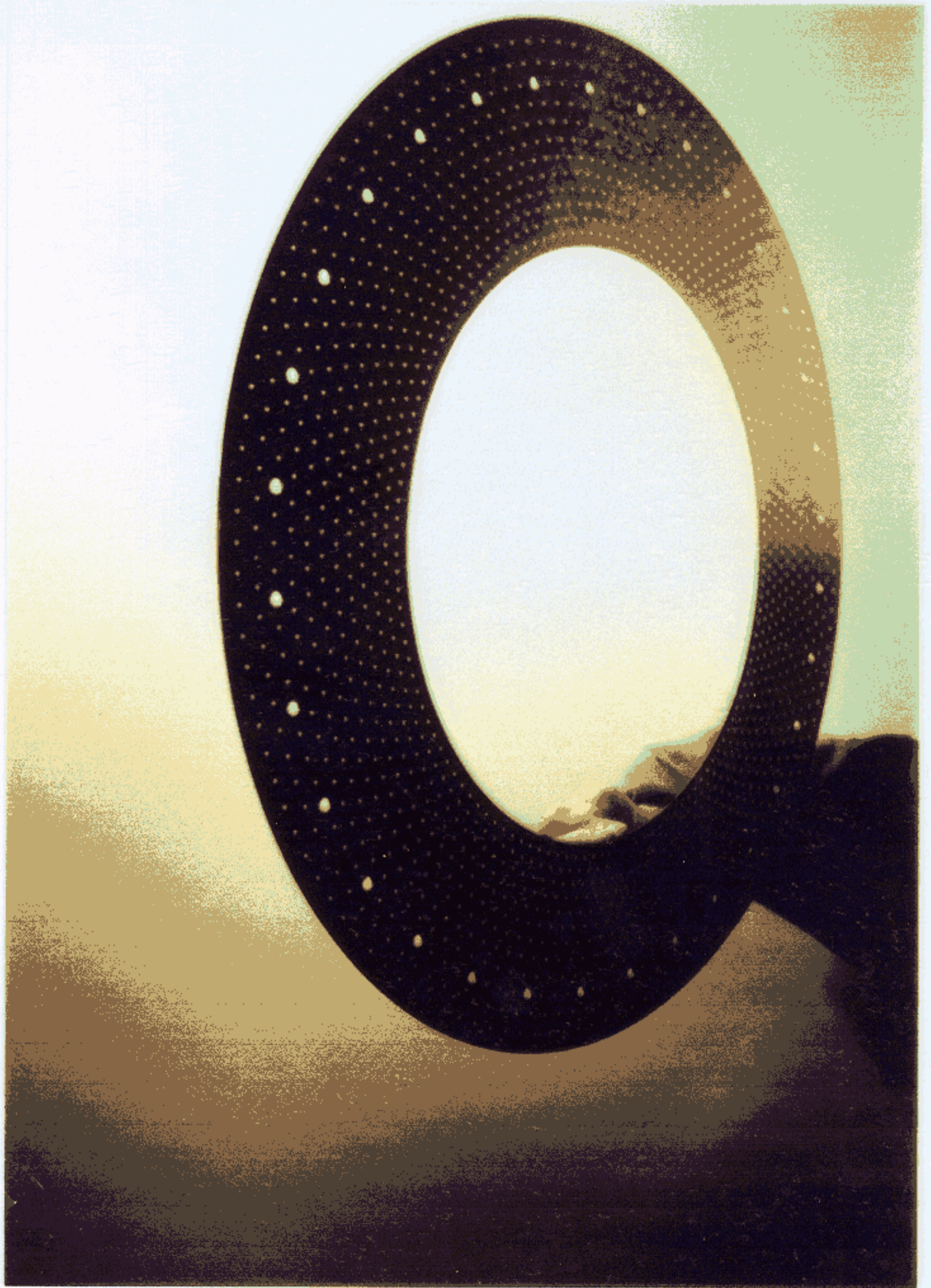

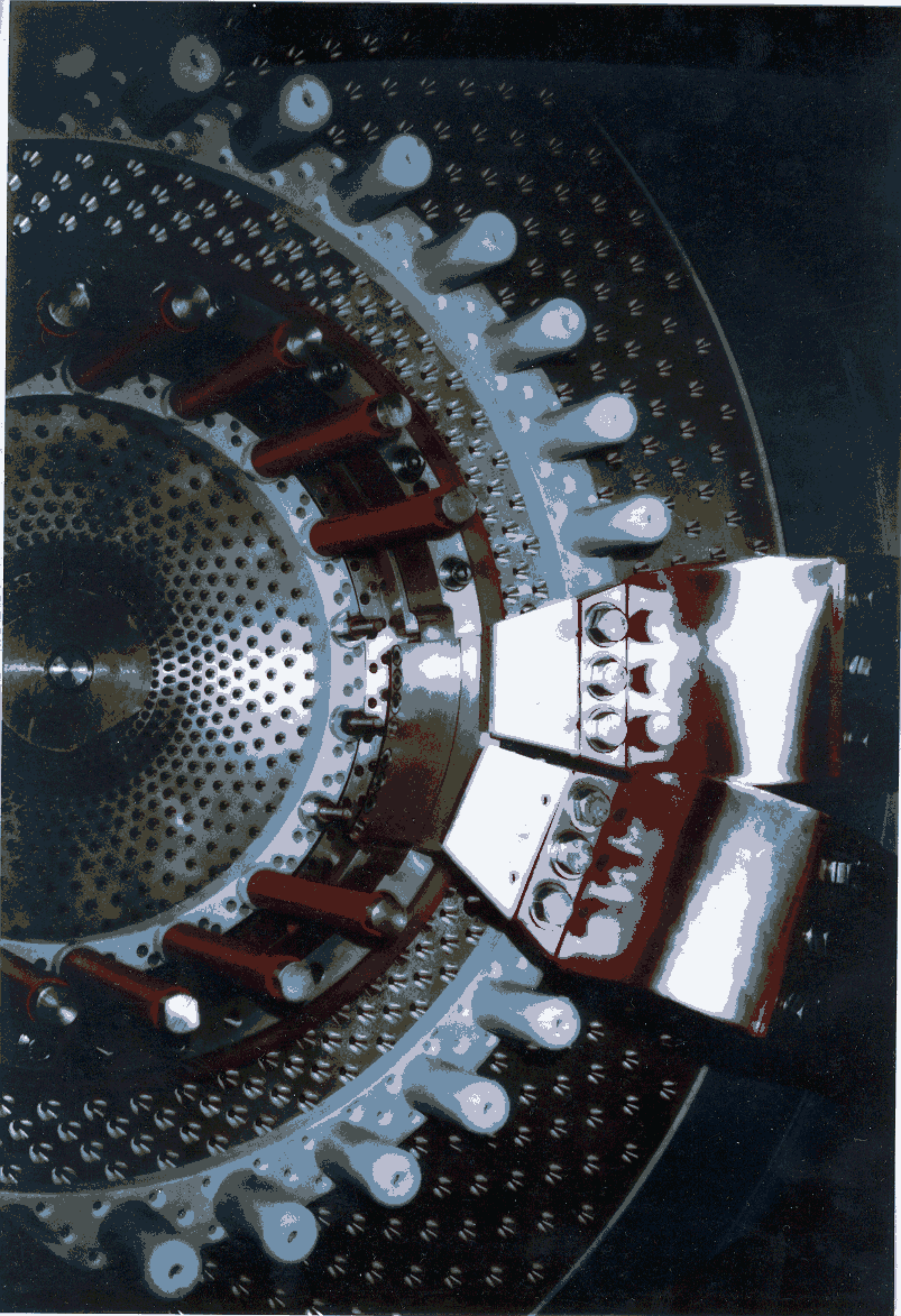

COOLING CIRCUIT

M10

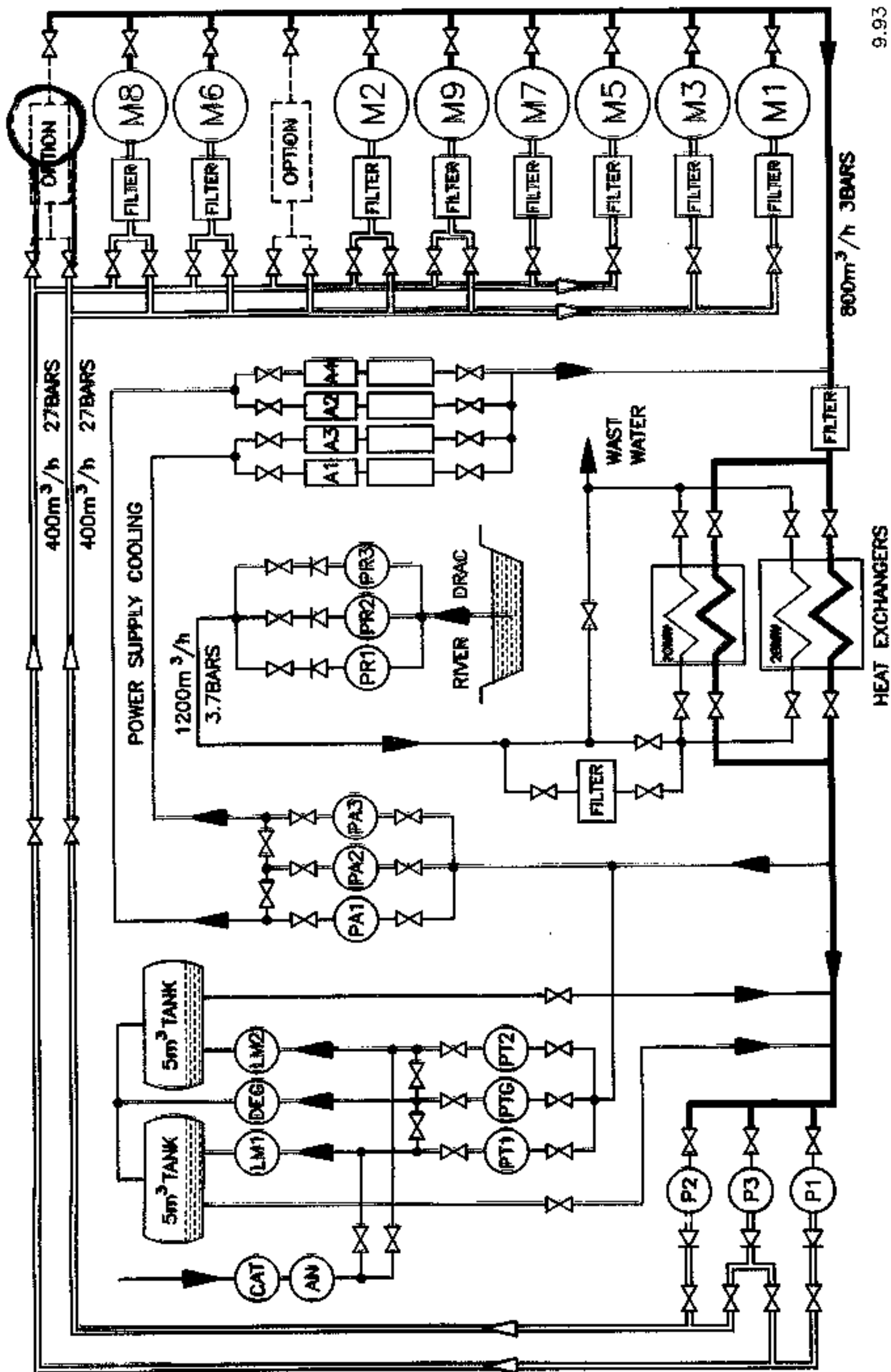

HEAT EXCHANGERS

zero flux de current transformer

1mH
 $V_{LC} = 17.5$

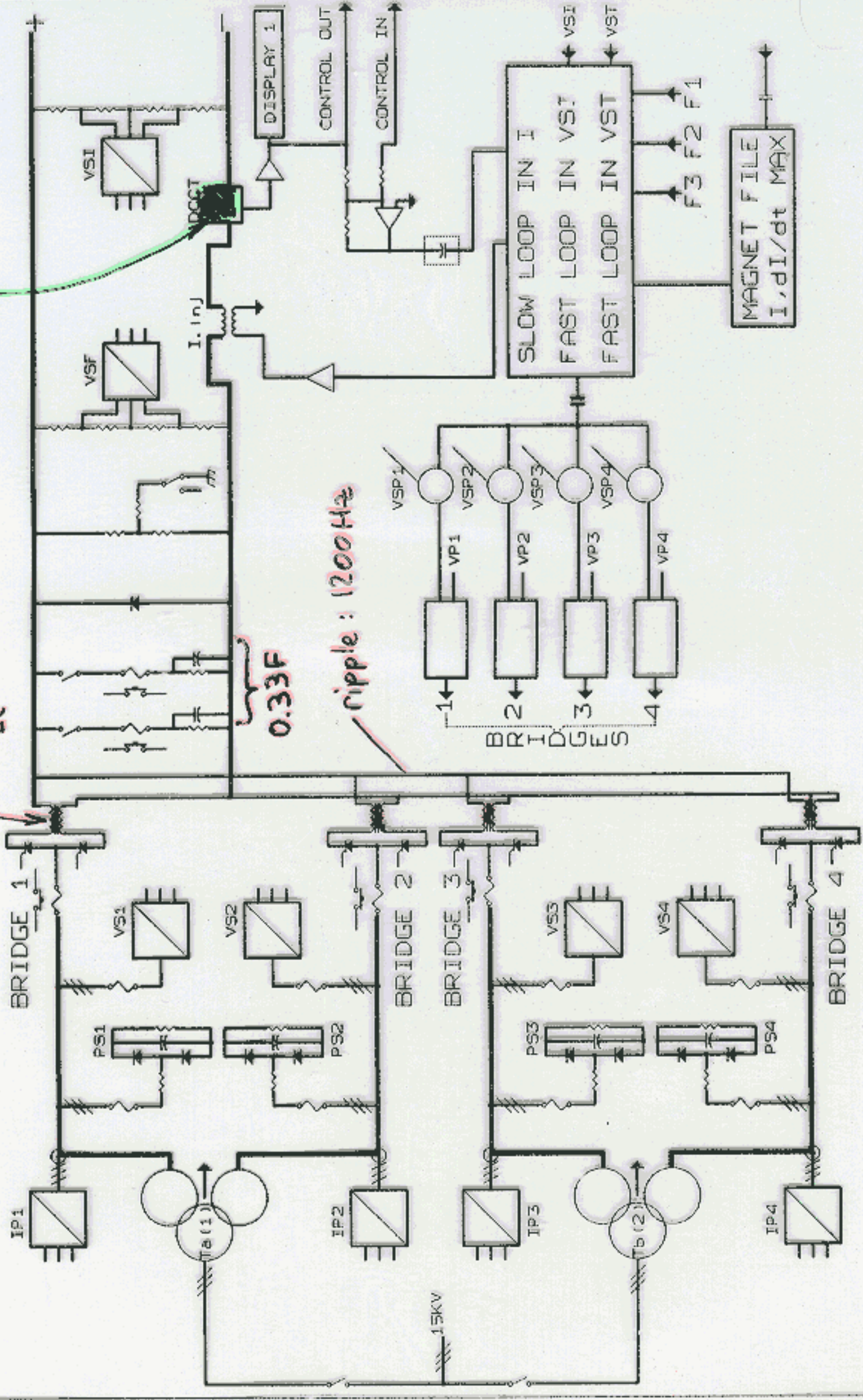

0.33F

ripple: 1200Hz

BRIDGES

MAGNET FILE
I, dI/dt MAX

SLOW LOOP IN I
FAST LOOP IN VST
FAST LOOP IN VST

F3 F2 F1

BRIDGE 1

BRIDGE 2

BRIDGE 3

BRIDGE 4

IP1

IP2

IP3

IP4

PS1

PS2

PS3

PS4

VS1

VS2

VS3

VS4

VSP1

VSP2

VSP3

VSP4

VP1

VP2

VP3

VP4

1

2

3

4

DISPLAY 1

CONTROL OUT

CONTROL IN

VSI

VST

I. Inj

VSI

VSF

Ta(1)

Tb(2)

15KV

MAIN CHARACTERISTICS OF THE HYDRAULIC PUMPS

Circuit	Cooling purpose	Number of pumps	Type	Outlet pressure bar	Flow m ³ /h	Speed rpm	Power kW	Control
Primary	Heat exchanger	3	Vertical immersed	3.7	600	1500	85	Automatic motor starter
Secondary	Magnets	3	Horizontal water cooled	27	400	1000 – 3000	450	Electric speed variators
Secondary	Power supplies	3	Vertical	8.0	50	2900	20	no
Secondary	Water treatment	3	Vertical	3.0	22	2900	3	no

RATING OF POWER SUPPLIES

	Number of Units	Power MW	Current kA	Voltage V
Nominal	4	6.3	15	420
Short period (<10 min)	4	6.93	16.5	420

PERFORMANCE OF POWER SUPPLIES

Ripple and noise 0 – 10 kHz peak to peak	50 ppm
Resolution of current command	4 ppm
Current calibration	100 ppm

Bitter magnet proposed by Walter Joss

2 solenoids : to reduce strains due to Lorentz forces

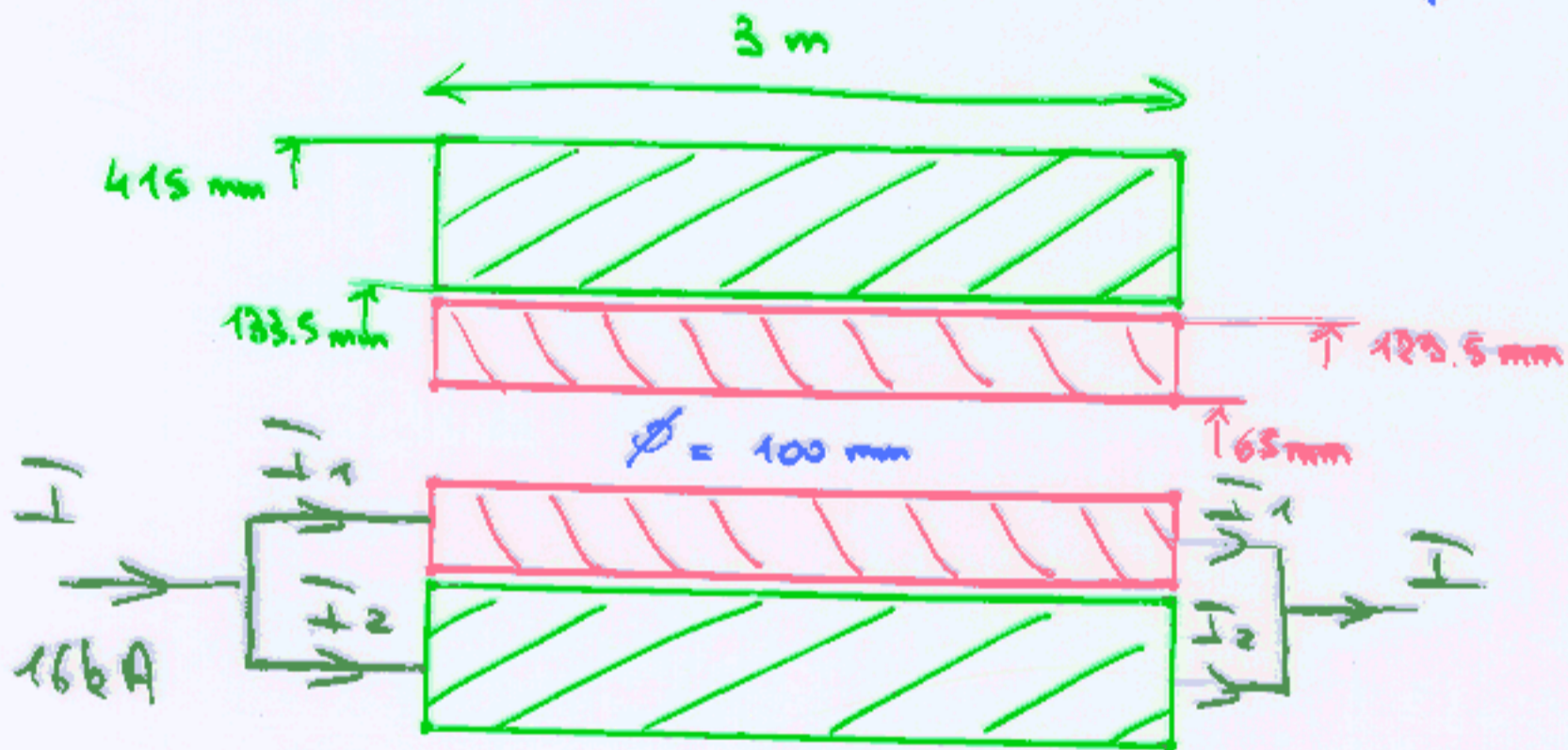

$$N = 1000 \text{ turns/m}$$

$$\begin{aligned} R_1 / \text{turn} &= 192 \mu \Omega \\ R_2 / \text{turn} &= 116 \mu \Omega \end{aligned} \quad R'' / \text{turn} = 72 \mu \Omega$$

$$P = 55 \text{ W}$$

$$\frac{B_1}{B_2} = \frac{I_1}{I_2} = \frac{R_2}{R_1} = \frac{7.5 \text{ T}}{12.5 \text{ T}}$$

if $B = B_1 + B_2 = 12 \text{ T} \Rightarrow P = 20 \text{ W}$
(hybrid magnet)

Cost

Bitter magnet:

Magnet:	2.5	π CHF	(α L)
D.C. supply + cooling:	25.0	π CHF	(α LB ²)
Consumption: 37 CHF/MWh 7 months/year 10 years	110.0	π CHF	(α LB ² t)
<hr/>			
	137.5	π CHF	

Hybrid magnet

Bitter magnet:	2.5	π CHF	(α L)
SC Magnet: (He cryogenics included) Industrial contract	12.5	π CHF	(α L)
D.C. supply + cooling:	7.5	π CHF	(α LB ²)
Consumption: 37 CHF/MWh 7 months/year 10 years	35.	π CHF	(α LB ² t)
<hr/>			
	57.5	π CHF	

Conclusion

- Technical solutions exist to build a 3m-20T solenoid
- A hybrid solution looks much cheaper
- The SC magnet may be ordered in industry
- The Bitter magnet could be done @ GMFL
- Check radiation levels and tolerance in SC magnet
- Optimize ϕ Q R^2